

---

# Installation and operation manual

**Q.PEAK DUO-G10.X solar module series**

# Table of contents



<b>1 Introduction</b>	<b>3</b>
<b>2 Planning</b>	<b>5</b>
2.1 Technical specifications	5
2.2 Requirements	6
2.3 Mounting options	7
2.4 Electrical layout	10
<b>3 Installation</b>	<b>11</b>
3.1 Safety and transport	11
3.2 Preparation of installation	13
3.3 Module installation	14
<b>4 Electrical Connection</b>	<b>15</b>
4.1 Safety	15
4.2 Electrical installation safety	16
4.3 Connection of modules	17
4.4 After installation	18
<b>5 Grounding</b>	<b>19</b>
<b>6 Faults and defects</b>	<b>20</b>
<b>7 Disposal</b>	<b>20</b>
<b>8 Maintenance and cleaning</b>	<b>21</b>

# 1 Introduction

**With solar modules from Hanwha Q CELLS America Inc. (hereafter referred to as "Qcells") you can directly transform the sun's limitless energy into environmentally-friendly solar electricity. In order to ensure the maximum performance of your Qcells solar modules, please read the following instructions completely and carefully and observe all guidelines. Non-compliance may result in damage and/or physical injury.**

This installation manual provides instructions for the safe installation and operation of crystalline solar modules.

- Please read these instructions carefully before proceeding with your installation.
- Please retain these instructions for the life of the solar modules.
- Please ensure that this Manual is available to the operator at all times.
- This Manual should be given to all subsequent owners or users of the solar modules.
- All supplements received from the manufacturer should be included.
- Please observe all other applicable documents.
- If your questions are not satisfactorily answered in the manual, please contact your system supplier.

Additional information can be found on our website at [www.qcells.com](http://www.qcells.com).

## Intended use

This manual is valid in North America for Qcells solar modules. These instructions contain information regarding the safe handling and use of quality crystalline solar modules from Qcells and their installation, mounting, wiring, maintenance.

## Symbols and Labels

The following symbols and labels are used throughout the Manual for ease of use.

SYMBOL	DESCRIPTION
→	Procedure with one or more steps.
■	Lists of items.
✓	Ensure that when carrying out a procedure, you check the results of said procedure.
⊘	Prohibited.



Beware of possible danger or damage.  
Categories:

- Danger: Risk of fatal injury
- Attention: Risk of serious injury or damage to property
- Note: Risk of damage to product

## Units

Where both Imperial and U.S. units (for example inches) are shown, metric units are definitive. References to "Data Sheet" or "Module Data Sheet" refer to the Module Data Sheet applicable to the module being used.

## Safety Regulations

The installer and solar module operator are responsible for compliance with all applicable statutory requirements and regulations.

→ The following regulations and standards must be upheld at all times during the installation, operation, and maintenance of the solar modules:

- Installation and Operation Manual.
- Other applicable documents (such as country-specific regulations for pressure equipment, operational safety, hazardous goods, and environmental protection).
- Regulations and requirements specific to the system.
- Applicable country-specific laws, regulations, and provisions governing the planning, installation, and operation of solar power systems and work on roofs.
- Any valid international, national and regional regulations governing work with direct current, especially those applicable to the installation of electrical devices and systems, and regulations issued by the respective energy provider governing the parallel operation of solar power systems.
- Accident-prevention regulations.

## Certified Personnel

Both, the operator and installer are responsible for ensuring that the installation, maintenance, connection to the grid, and dismantling are carried out by trained and qualified electricians and engineers with approved training certificates (issued by a state or federal organization) for the respective specialist trade. Electrical work may only be performed by an officially certified tradesperson in accordance with the applicable safety standards, accident prevention regulations, and the regulations of the local energy provider.

# 1 Introduction

## Validity

These instructions are only valid for crystalline solar modules from the company Qcells as specified at chapter "2.1 Technical specifications". Qcells assumes no liability for damage resulting from failure to observe these instructions.

- Please observe the wiring and dimensioning of the system.
- The installer of the system is responsible for compliance with all necessary safety regulations during set-up and installation. Qcells assumes no liability on the basis of these instructions. Qcells is only liable in the context of contractual agreements or in the context of accepted guarantees. Qcells accepts no other responsibility for the functionality and safety of the modules.
- Please observe the instructions for any other system components that may be part of the complete solar power system. It may be necessary to carry out a structural analysis for the entire project.
- If your questions are not satisfactorily answered in the manual, please contact your system supplier.

Additional information can be found on our website at [www.qcells.com](http://www.qcells.com).

## Information for the Operator

- Please keep this manual for the entire life of the solar power system.
- Please contact your system supplier for information concerning the formal requirements for solar power systems.
- Please be sure to contact the relevant local authorities and energy providers regarding regulations and permit requirements prior to installation of the solar power system. Your financial success depends on the fulfillment of these requirements.

## Other applicable documents

This installation manual is only valid in combination with the following technical information.

Document type
Product data sheet
Packaging and transport information

MISUSE OR INCORRECT USE OF SOLAR MODULES VOIDS THE LIMITED WARRANTY AND MAY CREATE A SAFETY HAZARD AND RISK PROPERTY DAMAGE. THIS INCLUDES IMPROPER INSTALLATION OR CONFIGURATION, IMPROPER MAINTENANCE, UNINTENDED USE, AND UNAUTHORIZED MODIFICATION.



**Attention!**  
This marking indicates that this product should not be disposed of with other household waste within the EU. Recycle this product properly to prevent possible damage to the environment or a risk to human health via uncontrolled waste disposal and in order to promote the sustainable reuse of material resources. Please return your used product to an appropriate collection point or contact the retailer where you purchased this product. Your retailer will accept used products and return them to an environmentally-sound recycling facility.



# 2 Planning

## 2.1 Technical specifications

For additional information see the relevant datasheet of the module provided at [www.qcells.com](http://www.qcells.com).

PRODUCT LINE	Q.PEAK DUO-G10 Q.PEAK DUO-G10+ Q.PEAK DUO-G10.a Q.PEAK DUO-G10.a+	Q.PEAK DUO BLK-G10 Q.PEAK DUO BLK-G10+ Q.PEAK DUO BLK-G10.a Q.PEAK DUO BLK-G10.a+	Q.PEAK DUO-G10.4 Q.PEAK DUO-G10.4+ Q.PEAK DUO BLK-G10.4 Q.PEAK DUO BLK-G10.4+
Type	Q.ANTUM DUO Z	Q.ANTUM DUO Z	Q.ANTUM DUO Z
Length [in]	637.6 (1717 mm)	637.6 (1717 mm)	637.6 (1717 mm)
Width [in]	41.1 (1045 mm)	41.1 (1045 mm)	41.1 (1045 mm)
Frame height [in]	1.26 (32 mm)	1.26 (32 mm)	1.26 (32 mm)
Area [yd <sup>2</sup> ]	2.14 (1.79 m <sup>2</sup> )	2.14 (1.79 m <sup>2</sup> )	2.14 (1.79 m <sup>2</sup> )
Weight [lbs]	43.9 (19.9 kg)	43.9 (19.9 kg)	43.9 (19.9 kg)
Max. system voltage V <sub>sys</sub>	1000 V	1000 V	1000 V
Max. series fuse rating	20 A	20 A	20 A
Permissible temperature range	-40°C to +85°C (-40°F to +185°F)		
Junction box protection class	IP67 with bypass diode		
Connector protection class	IP68		
Fire rating based on ANSI/UL 61730	C/Type 2	C/Type 2	C/Type 2
Max. test load Push/Pull <sup>1</sup> [lbs/ft <sup>2</sup> ]	169/84 (8,100 Pa/4,000 Pa)	169/84 (8,100 Pa/4,000 Pa)	169/84 (8,100 Pa/4,000 Pa)
Max. design load Push/Pull <sup>1</sup> [lbs/ft <sup>2</sup> ]	113/56 (5,400 Pa/2,660 Pa)	113/56 (5,400 Pa/2,660 Pa)	113/56 (5,400 Pa/2,660 Pa)
Certificates	CE-compliant; IEC 61215:2016; IEC 61730:2016; PV module classification: Class II; UL 61730; QCPV		
<sup>1</sup> Test and design load in accordance with IEC 61215:2016, depending on mounting options (see section "2.3 Mounting options")			

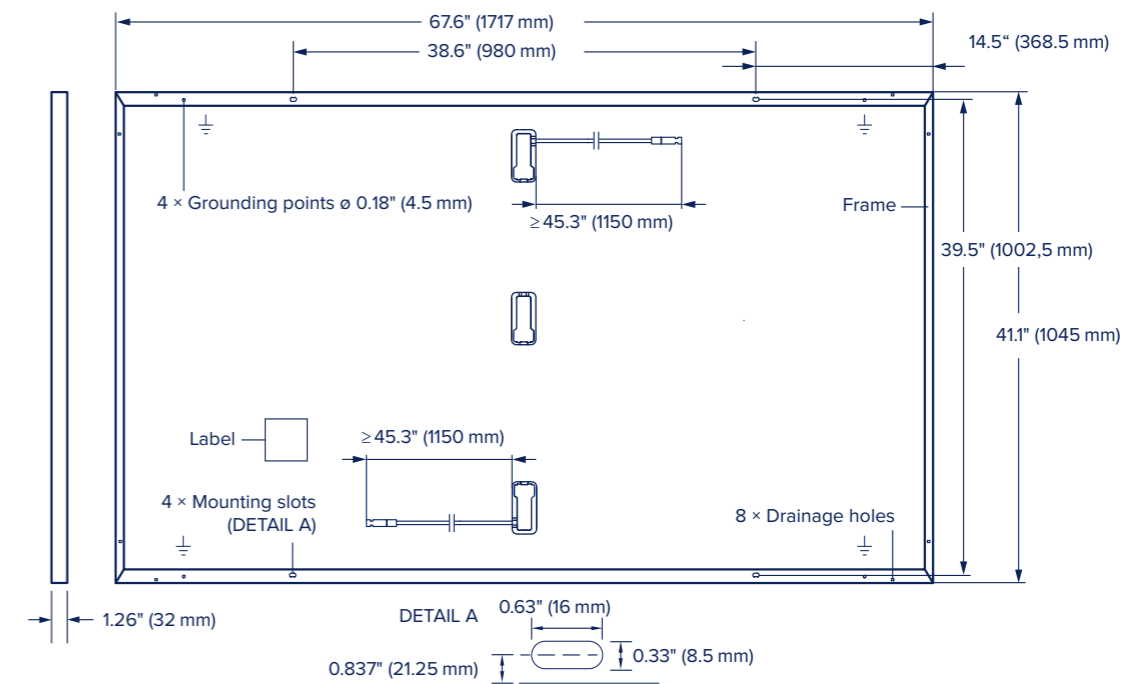

**Fig. 1:** External dimensions (in inch (mm)) and components for Q.PEAK DUO-G10, Q.PEAK DUO-G10+, Q.PEAK DUO-G10.a, Q.PEAK DUO-G10.a+, Q.PEAK DUO-G10.4, Q.PEAK DUO-G10.4+, Q.PEAK DUO BLK-G10, Q.PEAK DUO BLK-G10+, Q.PEAK DUO BLK-G10.a, Q.PEAK DUO BLK-G10.a+, Q.PEAK DUO BLK-G10.4 and Q.PEAK DUO BLK-G10.4+.

## 2 Planning

### 2.2 Requirements

#### Installation Site

Please note the following guidelines that apply to the installation site:

- Solar modules are not explosion-proof and are not suitable for use in explosive environments.
- Do not operate solar modules near highly flammable gas and vapors (e.g. gas tanks, gas stations).
- Do not install modules in enclosed space.
- Do not install modules in locations where they may be submerged in water (e.g. floodplains).
- Do not use modules as a substitute for the normal roofing (e.g. modules are not watertight).
- Do not install modules in close proximity to air conditioning systems.
- Do not install modules above 13,120ft (4,000m) altitude above sea level.
- Contact with saline water (e.g. spray water from the sea) and salt aggregation on the modules must be avoided.
- Do not bring any chemical substance (e.g. oil, solvent etc.) into contact with any part of the panel. Only substances, which are released by Qcells, are allowed to be used during installation, operation and maintenance.
- Any installation of modules on surfaces of water is prohibited. This includes installations on floating as well as pile-based platforms. Qcells may extend the coverage of its warranty to such installations, based on a case by case assessment of the system design and location. A prior written consent by the warrantor is required in any case.

#### Prevention of Shadowing Effects

Optimal solar irradiation leads to maximum energy output:

- For this reason, install the modules so that they face the sun.
- Avoid shadowing (due to objects such as buildings, chimneys or trees).
- Avoid partial shading (for example through overhead lines, dirt, snow).

#### Limitations

The solar modules are designed for the following applications:

- Operating temperatures from -40°F to +185°F.
- Pull loads and push loads according to chapter 2.3 ('Test Load' in accordance with IEC 61215 and 'Design Load x1.5' in accordance with UL 61730).
- Installation using a mounting structure for solar modules.

#### Mounting Structure Requirements

Requirements for the mounting structure:

- Conform to the necessary structural requirements.
- Compliant with local snow and wind loads.
- Properly fastened to the ground, the roof, or the façade.
- Forces acting on the module are relayed to the mounting substructure.
- Ensures sufficient rear ventilation of the module.
- Avoid the usage of different metals to prevent contact corrosion.
- Allows for stress-free expansion and contraction due to temperature fluctuations.

- Ensure that no additional forces are applied through the mounting system into the module except for the wind and snow loads. Additional forces and moments of torque at the mounting positions caused by torsions, displacements or vibrations in the mounting system are not allowed.
- Ensure that the clamps and the mounting frame are compatible.

#### Clamp System Recommendations

Use customary clamps that satisfy the following requirements:

- Clamp width:  $\geq 1.57$  in (40 mm).
- Clamp height compliant with a 1.26 in (32 mm) frame height.
- Clamp depth: 0.28-0.47 in (7-12 mm). (applicable for all CL clamping mounting options at section "2.3 Mounting Options")
- Clamps are not in contact with the front glass.
- Clamps do not deform the frame.
- Clamps that satisfy the structural requirements based on the conditions of the installation site according to the applicable regulations and technical standards.
- Long-term stable clamps that securely affix the module to the mounting frame.

#### Module Orientation Requirements

- Vertical or horizontal installation is permitted.
- Ensure that rain and melting snow can run off freely. No water accumulation.
- Ensure that the drainage holes in the frame are not covered. No sealing.

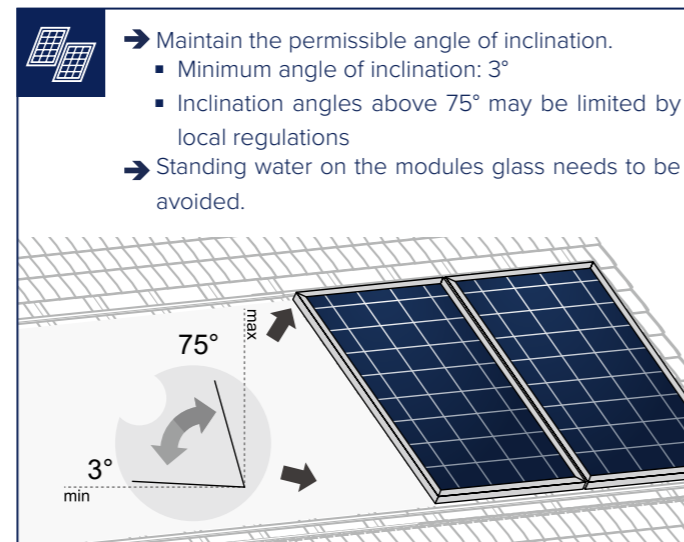

## 2 Planning

### 2.3 Mounting options

The module is considered to be in compliance with UL 61730 only when the module is either mounted in the manner specified by the mounting instructions, or when the mounting means has been evaluated with this PV module to UL 2703. A module with exposed conductive parts is considered to be in compliance with UL 61730 only when it is either electrically grounded in accordance with the manufacturer's instructions and the requirements of the National Electrical Code, ANSI/NFPA 70 (2014-2017), or when the bonding means has been evaluated with this module to UL 2703.

Fig. 2: Installation options for crystalline Qcells modules. All dimensions are given in inch (mm in brackets). Also observe the maximum test loads and clamping range as specified on the following page. The illustrated installation options apply for both horizontal and vertical module orientation.

TYPE OF INSTALLATION	POINT MOUNTING SYSTEM		LINEAR MOUNTING SYSTEM
	CL1a	CL1b	CL3
Installation with clamps			
Hybrid clamping			

## 2 Planning

### 2.3 Mounting options

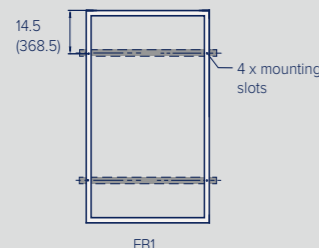
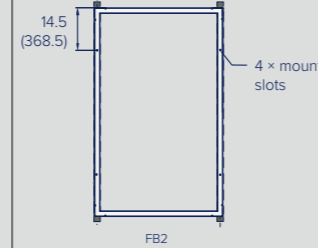
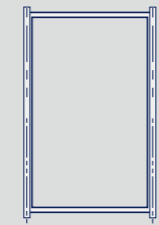
TYPE OF INSTALLATION	POINT MOUNTING SYSTEM	LINEAR MOUNTING SYSTEM
Installation on mounting points		
Installation with insertion profiles	not permitted	

#### Specifications

MOUNTING OPTION	POSITION OF CLAMPS* [IN]	TEST LOAD PUSH/PULL** [Pa]	DESIGN LOAD PUSH/PULL** [Pa]	SAFETY FACTOR
CL1a	5.12 - 13.8 (130 - 350mm)	5400/4000	3600/2660	1.5
	0.79 - 17.7 (20 - 450mm)	5400/3600	3600/2400	
	0.79 - 25.6 (20 - 650mm)	2400/2400	1600/1600	
CL1b	11.8 - 19.7 (300 - 500mm)	2400/2400	1600/1600	
CL2a (with rails)	0.79 - 11.8 (20 - 300mm)***	3600/2400	2400/1600	
CL2b (without rails)	0.79 - 7.87 (20 - 200mm)	2400/2400	1600/1600	
CL3	9.45 - 13.8 (240 - 350mm)	4000/4000	2660/2660	
FB1	14.5 (368.5mm)	5400/4000	3600/2660	
FB2	14.5 (368.5)mm	4000/4000	2660/2660	
IP1	-	3600/3300	2400/2200	
CL5	short side: 0.79 - 3.94 (20 - 100mm) long side: 11.8 - 17.7 (300 - 450mm)			
CL6a	outer clamps: 0.79 - 15.7 (20 - 400mm) middle clamps: 22.0 - 45.7 (560 - 1160mm)***	8100/4000	5400/2660	
CL6c	outer clamps: 0.79 - 15.7 (20 - 400mm) middle clamps: 22.0 - 45.7 (560-1160mm)***	3600/3600	2400/2400	
CL6d	short side: 0.79 - 9.8 (20 - 250mm) long side: 22.0 - 45.7 (560-1160mm)***	4000 / 3600	2660/2400	

\* Distance between outer edge of module and middle of the clamp; consider further details below.  
 \*\* Loads according to IEC 61215-2:2016 and UL 61730.  
 \*\*\* Rails must not be under the junction box.

## 2 Planning

### 2.3 Mounting options

MOUNTING OPTIONS	REQUIREMENTS
All	<ul style="list-style-type: none"> <li>→ The loads in the table are related to the mechanical stability of the solar modules. The mechanical stability of the mounting system including clamps has to be evaluated by the system supplier. The listed test load values have been determined with the following clamp parameters: clamp width = 1.57 in (40 mm) and clamp depth = 0.39 in (10 mm).</li> <li>→ The system installer is responsible for the determination of location-specific load requirements.</li> <li>→ Ensure that the connection cables of the junction box do not run between laminate and mounting rails.</li> <li>→ Modules bend under load. Therefore, sharp objects (e.g. screws, ballast stones, rail ends, rails with burrs or sharp corners) must not be placed near the module backside so as not to touch the laminate under load.</li> <li>→ Ensure that the junction boxes do not touch the mounting structure (e.g. shorts rails, ballast, etc.) or the rooftop under load. Clamps or insertion profiles etc. must not touch the glass (even under load).</li> <li>→ Unbalanced loads (e.g. snow overhangs, snowdrifts) which result in locally significantly increased loads must be removed or avoided by technical measures.</li> </ul>
CL1a, CL2a, CL3, CL6a, FB1, FB2	→ Ensure that module frame is fixed directly on the rail of the substructure (no spacer allowed between the module and substructure).
CL1a	→ At push test loads of 5400 Pa: The clamp position is variable in the given range but the distance between the clamps along the long side of the module (span) must not be larger than 49.21 in (1250 mm).
CL1b	→ Using of short mounting rails are permissible, if they overlap under the module less than 8.27 in (210 mm). Minimum clearance between frame bottom edge and roof top must be ≥1.38 in (35 mm).
CL1b, CL2b, CL3, FB2, CL6c, CL6d	→ A minimum support depth of 0.59 in (15 mm) is required on the back side of the module.
CL5	→ The minimum required support depth on the module backside is 0.39 in (10 mm) on long frame side and 0.59 in (15 mm) on short frame side.
IP1	→ Ensure minimum support depth of 0.59 in (15 mm) on the backside and 0.39 in (10 mm) on the front side of the module.
FB1, FB2	→ Use M8 corrosion-proof screws and washers (diameter ≥0.62 in (15.8 mm)) for mounting slots (Detail A, Fig.1). Mounting screws and washers should have the same material properties.
CL6c, CL6d	→ Use of short mounting rails under the modules are permissible, if they do not touch the laminate under load.



## 2 Planning

### 2.4 Electrical layout

#### Module Selection

For detailed key electrical data, please refer to the actual data sheet referring to the relevant Module (available at [www.qcells.com](http://www.qcells.com)).

→ For maximum energy yields, mismatches of specified electric current ( $I_{MPP}$ ) of more than 5 % should be avoided for all modules connected in series.

#### Safety Factor

During normal operation, a module may generate a greater current and / or higher voltage than that determined under standardized test conditions. Accordingly, the values of ISC and VOC marked on the module should be multiplied by a factor of 1.25 when determining:

- the component voltage ratings,
- conductor ampacities,
- fuse sizes,
- size of controls connected to the PV output.

Refer to Section 690-8 of the National Electrical Code for an additional multiplying factor of 125 percent (80 percent derating) which might be applicable.

→ Please follow the valid national guidelines for the installation of electrical systems (refer to section 690-8 of the NEC for an additional multiplying factor of 125 percent [80 percent derating] which may be applicable).

#### Series Connection

Connection of modules in series is only permitted up to the maximum system voltage as listed in the applicable data sheet.

→ Take into account all possible operating situations and all relevant technical norms and regulations when designing the system. It has to be ensured that the maximum system voltage, including all necessary safety margins, is not exceeded.

→ Take the voltage limit of the inverter into account when determining the maximum number of modules in the string.

#### Parallel Connection

Modules may be damaged by the occurrence of reverse currents (caused by module defects, ground leaks, or defective insulation).

→ Ensure that the maximum reverse current load capacity indicated in the data sheet is met.

In order to limit reverse currents that may occur, we recommend using the following safety options:

##### 1) Layout with a limited number of parallel connected strings:

Without undertaking further current blocking measures, a maximum of two module strings may be operated in parallel on a single inverter or MPP tracker.

##### 2) Layout with string fuses:

Use overcurrent devices (e.g. fuses) according to the relevant standards in each string. Use gPV-fuses according to IEC 60269-6. Observe the maximum permitted number of strings as indicated in the specifications provided by the respective string fuse manufacturer and the technical guidelines.

#### NOTE!

When installing different product versions, the lowest minimum permitted reverse current load capacity applies.

#### Inverters

Inverters with or without transformers may be used.

## 3 Installation

### 3.1 Safety and transport

! → Ensure that all personnel are aware of and adhere to accident-prevention and safety regulations.  
→ While working wear clean gloves.

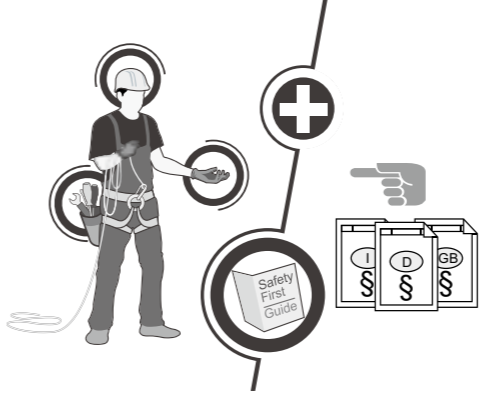

! **Danger! Risk of fatal injury due to electric shock!**  
→ Do not install damaged modules.  
→ Inform your distributor of any damages immediately.

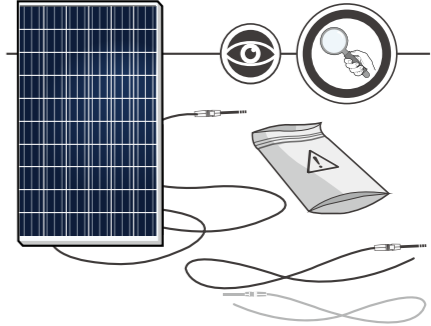

! → Inspect the packaging for damages.  
→ Contact the transport company regarding any damage to the packaging and follow their instructions.  
→ Follow any instructions on the packaging.



! **Warning! Fire Risk!**  
→ Do not install modules indoors.  
→ Do not install modules on moving objects.



! → Leave modules in their original packaging until installation.  
→ Store the modules securely in cool and dry rooms. The packaging is not weatherproof.

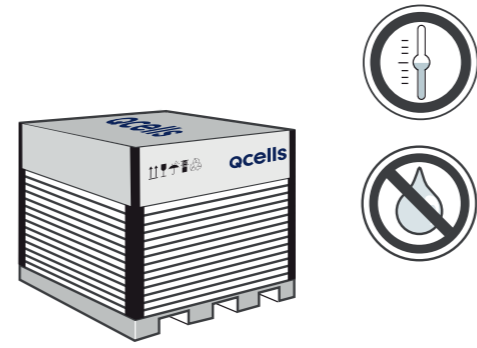

### 3 Installation

#### 3.1 Safety and Transport

**! Note! Module damage may occur!**

- Never lift or move the module with the connection cables or junction box.
- Carry modules upright and horizontally as shown.

**! Note! Module damage may occur!**

- Never step on modules.
- Do not subject modules to any mechanical stress.
- Do not allow any objects to fall onto modules

**! Note! Module damage may occur!**

- Do not drop modules.

**! Note! Module damage may occur!**

- Only make modifications to the module which have been confirmed in writing by Qcells.

**! Note! Module damage may occur!**

- Do not stack modules.

**! Note! Module damage may occur!**

- Do not install modules near flammable gas/vapors.
- Do not install modules in close proximity to air conditioning systems.

### 3 Installation

#### 3.2 Preparation of installation

**! Danger! Risk of fatal injury due to electric shock!**

- Block off the installation zone.
- Keep children and unauthorized individuals away from the solar power system.

**! Warning! Risk of injury due to falling modules!**

- Secure modules during installation.
- Do not install modules in windy or wet weather.

**! Danger! Risk of fatal injury due to electric shock!**

- Only use dry, insulated tools.

**! → Do not carry out the installation alone.**

**! Danger! Risk of fatal injury due to electric shock!**

- Ensure that modules and tools are not subject to moisture or rain at any time during installation.

**! Only install undamaged modules and components.**

- Do not modify the module (e.g. do not drill any additional holes).

## 3 Installation

### 3.3 Module installation

**Option 1:**

- Fasten the module with 4 clamps in the specified clamping range, see Fig. 2, p. 7.
- Tighten clamps according to manufacturer's instructions.

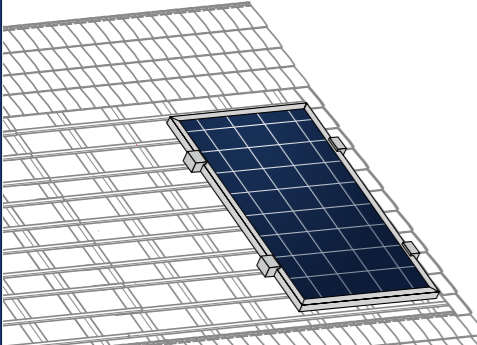

**Option 1:**

- Maintain an interval of at least 0.39 in (10 mm) between two modules along the short side and 0.20 in (5 mm) along the long side.

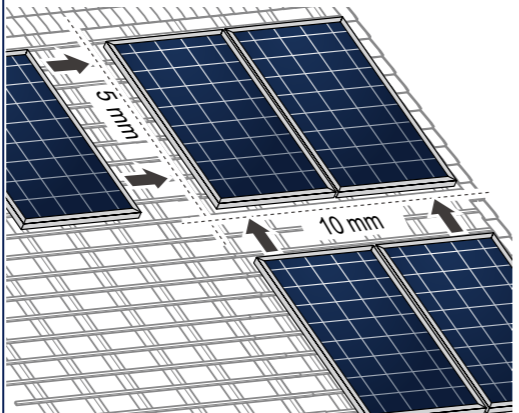

**Option 2:**

- Install the module at the 4 mounting points, see Fig. 2, p. 7.
- Tighten screws according to manufacturer's instructions.

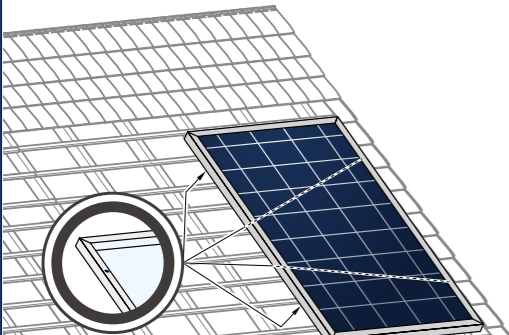

**Note! Module damage may occur!**

- Do not subject modules to mechanical tension. Max. torsion 0.12 in / ft (10 mm/m).

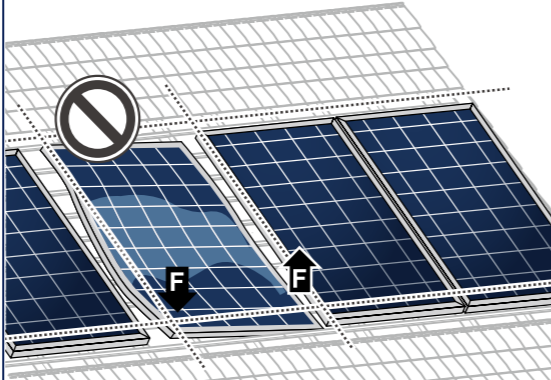

**Option 3:**

- Install the module using mounting profiles, see Fig. 2, p. 7.

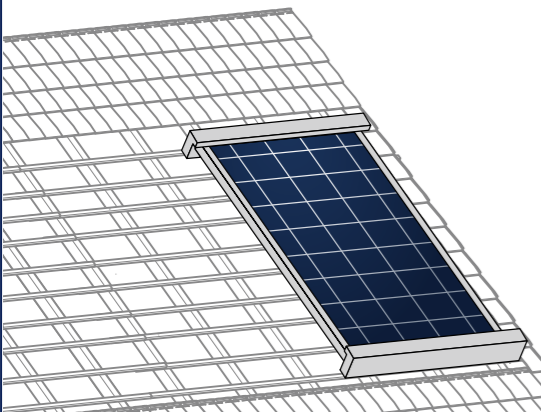

## 4 Electrical Connection

### 4.1 Safety

**Danger!**  
**Risk of fatal injury due to electric shock!**

When disconnecting an electric circuit carrying direct current, electric arcs can occur that may result in life-threatening injuries.

- Do NOT unplug the cable when under load.
- Do NOT connect any exposed cable ends.
- Electrical work may only be performed by qualified and skilled personnel (see page 3).

**A solar module generates electrical current and voltage even at a low intensity of illumination. Sparks and electric arcs may result from the separation of a closed circuit. These can result in life-threatening injuries. The danger increases when several modules are connected in series.**

- Please be aware of that the entire open circuit voltage is active even at low levels of solar irradiation.
- Please follow the valid national regulations and safety guidelines for the installation of electrical devices and systems.
- Please make sure to take all necessary safety precautions. With module or phase voltages of more than 120 V, the safety extra-low voltage range is exceeded.
- Carry out work on the inverter and the wiring with extreme caution.
- Ensure that the modules are disconnected at the inverter prior to separation.
- Be sure to observe the time intervals specified by the inverter manufacturer after switching off the inverter.
- Make sure that the plugs can not be connected unintentionally.
- Before working on the contacts, check them for safety extra-low voltage.

**Danger! Risk of fatal injury due to electric shock!**

- Never open the junction box.
- Do not remove bypass diodes.

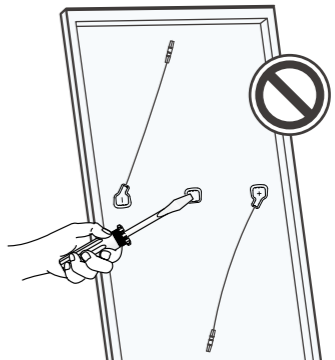

**Danger! Risk of fatal injury due to electric shock!**

- Never touch live contacts with bare hands.
- Cover connectors by suitable protective caps until installation.

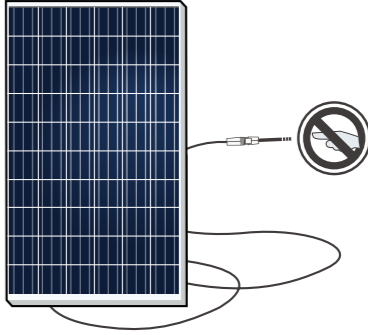

**Danger! Risk of fatal injury due to electric shock!**

- Only use dry, insulated tools for electrical work.

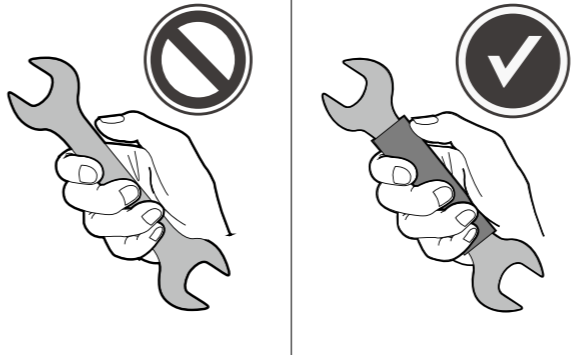

**Danger! Risk of fatal injury due to electric shock!**

- Insulate any exposed cable ends.
- Only connect cables with plugs.

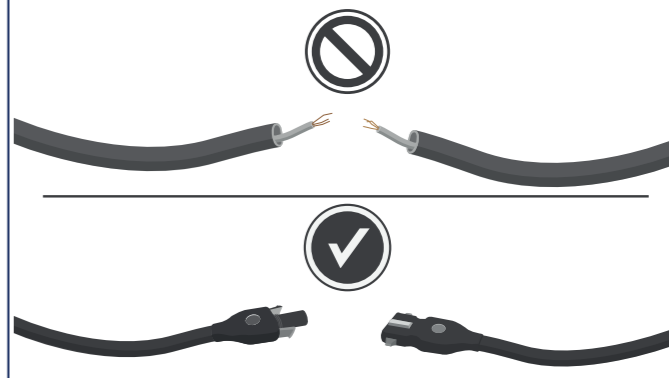



## 4 Electrical Connection

### 4.2 Electrical installation safety

**! Danger! Risk of fatal injury due to electric shock!**

- Electrical work may only be performed by qualified and skilled personnel (see page 3).
- Ensure correct polarity.

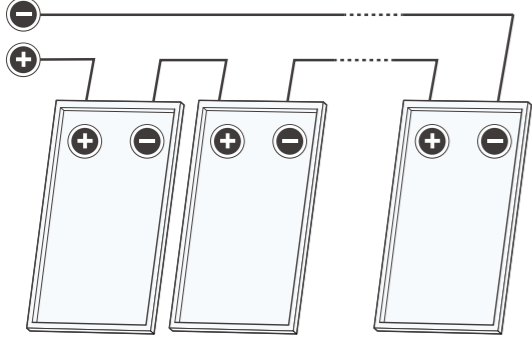

**! Danger! Risk of fatal injury due to electric shock!**

- Never plug or unplug the cable when under load. Modules must not carry any current.

1. Switch off the inverter.

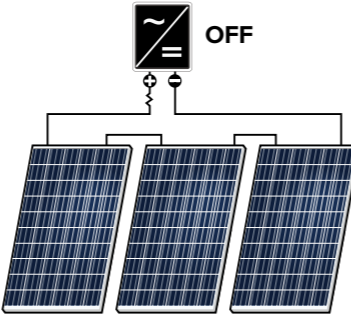

**! Danger! Risk of fatal injury due to electric shock!**

- Be sure to maintain the time intervals as specified by the inverter manufacturer between switching off the inverter and beginning any further work.

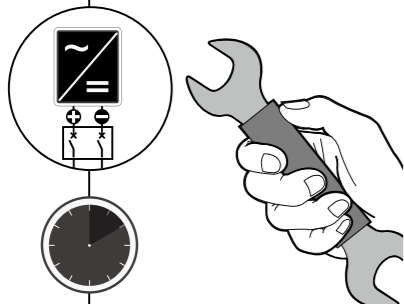

**! Danger! Risk of fatal injury due to electric shock!**

2. Switch off the DC circuit breaker.
3. Measure shutdown in DC String. (no DC current flow).
4. Disconnect plugs by the use of appropriate and qualified tools of the manufacturer.
5. When connecting the modules proceed in reverse order.

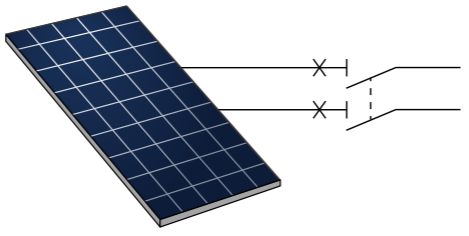

## 4 Electrical Connection

### 4.3 Connection of modules

**! Danger! Risk of fatal injury due to electric shock!**

- Use solar cables for the connection at the junction box outlet.
- Only interconnect connectors of the same type and manufacturer.
- Use minimum No. 12 AWG copper wires insulated for a minimum of 90°C for field connections.

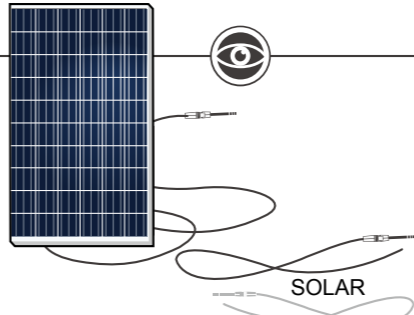

**! Note! Module damage may occur!**

- Ensure that the cabling is not under mechanical stress (Comply with bending radius of  $\geq 2.36$  in (60 mm)).
- Ensure that the cables do not run between module and mounting rail or structure (danger of pinch).

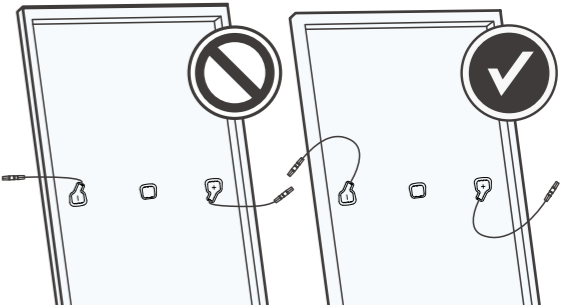

**! Danger! Risk of fatal injury due to electric shock!**

- Ensure that all electrical components are in a proper, dry, and safe condition.

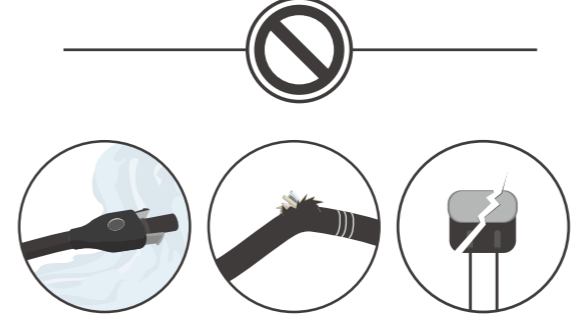

**! Danger! Risk of fatal injury due to electric shock!**

- Do not connect modules with different orientations or angles of inclination in the same string.

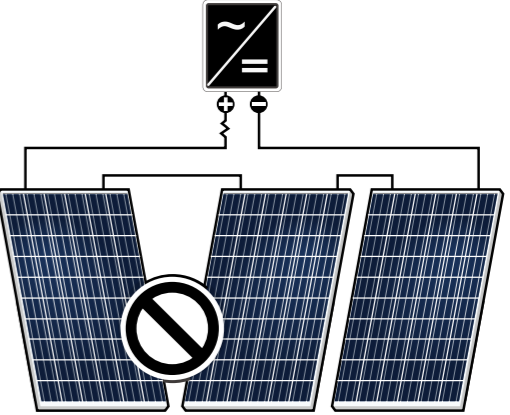

**! Danger! Risk of fatal injury due to electric shock!**

- Ensure for a tight connection between the plugs. Plugs click together audibly.

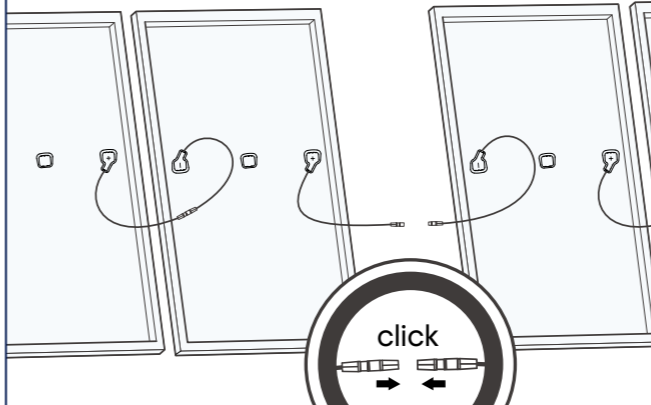

## 4 Electrical connection

### 4.4 After installation

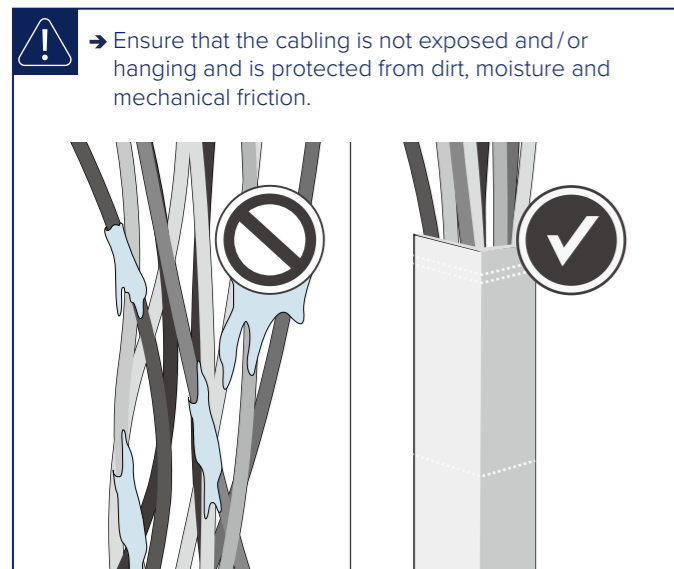
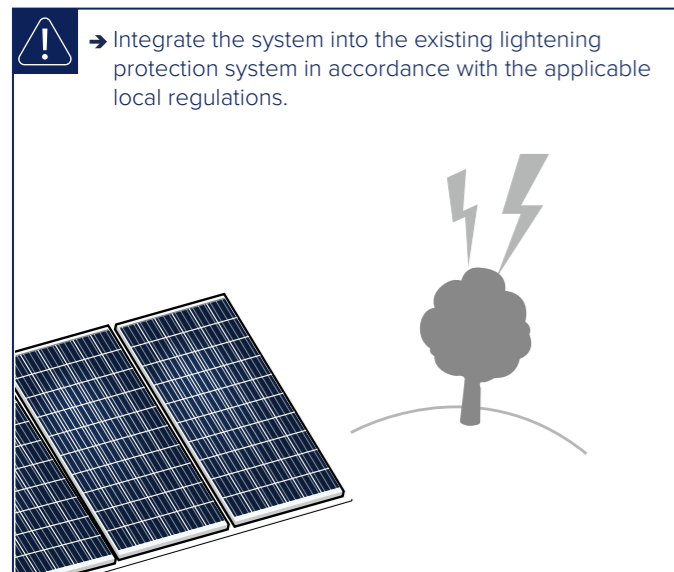
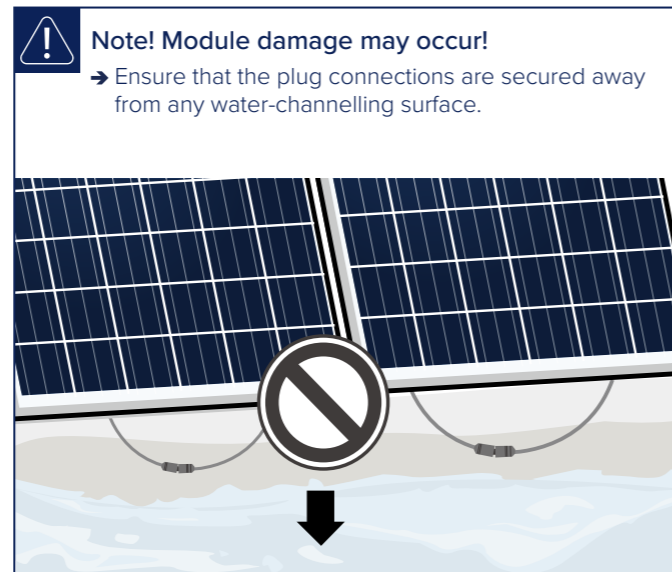

## 5 Grounding

### Protective Grounding

In order to prevent electrical shock or fire, the frame of the module as well as any non-current-carrying metal parts of the system must be grounded. While this section provides some information about grounding the Qcells frames and modules, reference should be made to local statutes and regulations for specific requirements on grounding. The U.S. National Electrical Code addresses these issues in Article 250. A module with exposed conductive parts is considered to be in compliance with this standard only when it is either electrically grounded in accordance with the manufacturer's instructions and the requirements of the National Electrical Code, ANSI/NFPA 70 (2014-2017), or when the bonding means has been evaluated with this module to UL 2703.

Proper grounding is achieved by bonding all exposed non-current-carrying metal equipment to the appropriately sized equipment grounding conductor (EGC) or racking system that can be used for integrated grounding.

Qcells frames are protected from corrosion with an anodized coating, which has to be penetrated in order to ensure proper bonding. The different methods listed below are suggested methods for an appropriate bond between the frame and the EGC or racking system (that will have to be properly grounded). The method appropriate for any individual installation will depend on multiple factors.

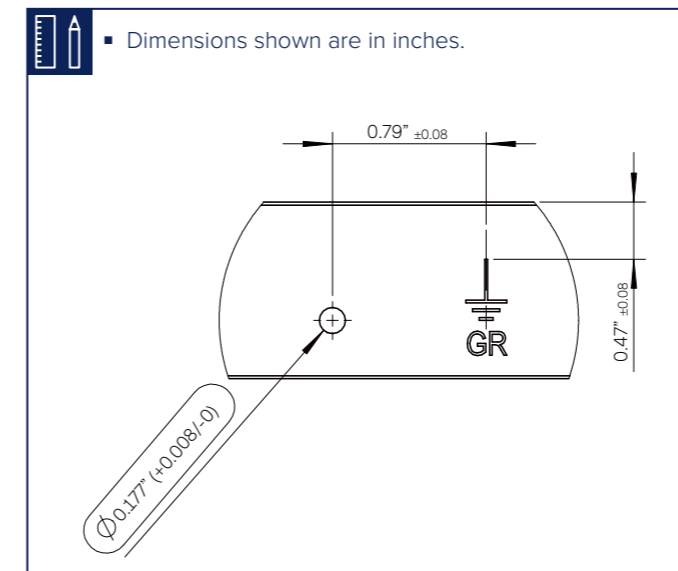

### Option A: Use of a grounding lug

A listed grounding lug can be bonded to the frame using the grounding holes pre-drilled in the frame. These holes are marked with a ground symbol, as shown below on the frame section drawing: To install the grounding lug, follow the specified instructions of the manufacturer. The grounding lug should be made of stainless steel or tin plated metals such as aluminum to avoid corrosion.

The grounding lug should be attached to the frame grounding hole using a stainless steel screw, toothed lock washer or KEPS nut (in order to penetrate the anodized layer) and backing nut. Care should be taken to avoid the use of grounding hardware of dissimilar metals, which may lead to corrosion.

### Option B: Integrated grounding methods

The Qcells modules can be bonded with the racking system using UL1703 or UL2703 certified integrated grounding methods. The racking system will then have to be grounded so that the overall system is properly grounded. The listed racking system and grounding device should be installed in accordance with the manufacturers' instructions. An example of such integrated grounding method is the use of a WEEB clip or Schletter plate between the module and the racking system, when mounting the module.

The WEEB washers are generally compatible with Qcells modules, however each combination module/racking system requires a specific WEEB washer size. Note that WEEB clips are intended for single use only; they must not be reused after removal or loosening. Refer to Wiley's installation instructions for the specific use of WEEB washers.

An example of such integrated grounding method is the use of a washer recognized as meeting UL2703 requirements between the module and the racking system, when mounting the module. For example, WEEB washers are generally compatible with Qcells modules, however each combination module/racking system requires a specific WEEB washer size. Note that WEEB washers are intended for single use only; they must not be reused after removal or loosening. Refer to Wiley's installation instructions for the specific use of WEEB washers.

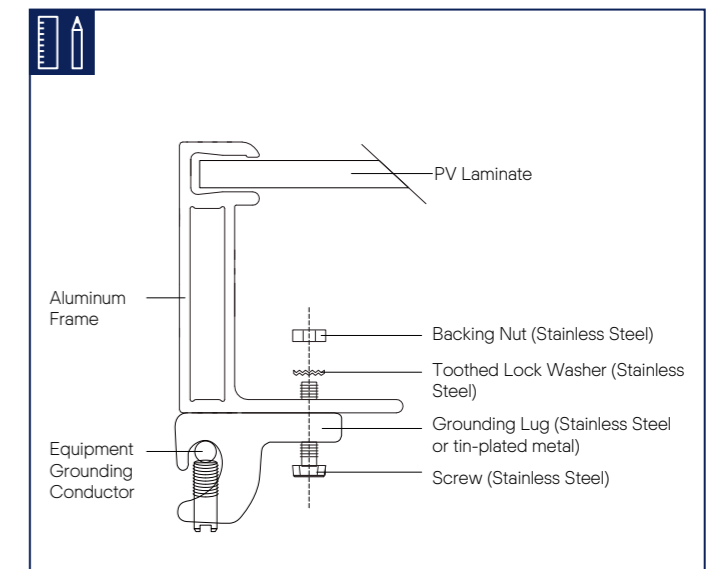

## 6 Faults and defects



**Danger!**  
Risk of fatal injury due to electric shock!

- Do not attempt to fix any problems yourself (e.g., glass cracks, damaged cables).
- Please contact an installer or Qcells Technical Customer Service Department.

## 7 Disposal

- Do not disconnect modules by yourself.
- Please commission a trade specialist.
- Dispose of modules in accordance with the local disposal regulations.

## 8 Maintenance and cleaning

**Qcells solar modules are known for a long operating life and minimal maintenance effort and expense. Dirt and grime are usually washed away by rain. If the module is fully or partially shaded by dirt or debris (e.g., plants, bird droppings), it needs to be cleaned to prevent a loss of performance.**

### Maintenance

- The PV system has to be inspected regularly by certified personnel
- The time intervals and extent of the inspection can depend on local circumstances (e.g. salt, ammonia content in the air, high humidity etc.). The customer/operator must inform himself about time intervals and extend of necessary inspections.
- Inspections have to be performed especially after extraordinary events (e.g. storm, hail, high snow loads etc.)
- During the inspections it has to be checked that the components are secure, undamaged and clean

### Cleaning



**WARNING!**  
Risk of injury due to hot and live modules!

- Only clean modules that have cooled down.
- Do not carry or wear any electrically conductive parts.



**WARNING!**  
Risk of falling due to unsecured access!

- Never access the installation area alone or without taking adequate security precautions.
- Please commission a trade specialist.



**NOTE!**  
Module surface damage may occur!

- Remove snow and ice carefully without force (e.g. with a very soft broom).
- Do not scratch off dirt.
- Module cleaning has to be done by qualified personnel according to the state of the art and taking into account all relevant safety issues and general product properties, e.g., but not restricted to:
  - electrical safety
  - mechanical stability (load limits depending on the actual mounting options)
  - chemical suitability (no effect to any of the module's components, e.g. cable, connector, silicone)
  - no abrasive materials.



**NOTE!**  
Dust and dirt are abrasive materials!

- The situation for each individual project (or type of dirt) must always be professionally evaluated.
- Wrong cleaning may cause damages such as, but not limited to, damages to the glass surface (e.g. scratches) and AR coating, power loss, delamination, loss of frame-to-laminate bond, reduced snow and wind load capability etc.

**Apart from the above, each customer is free to choose the method of cleaning. However, possible damages, caused by the cleaning or related to the cleaning tools or agents shall not be covered by the module's Product and Performance Warranty. Therefore it is recommended to use only the tools and agents which have already been successfully tested and used with PV modules, to prevent possible damage.**

**Isopropyl alcohol (IPA) can be used selectively to remove stubborn dirt and stains within one hour after emergence.**



**Note! Module damage may occur!**

- Do not clean modules with water if there is a risk of frost.

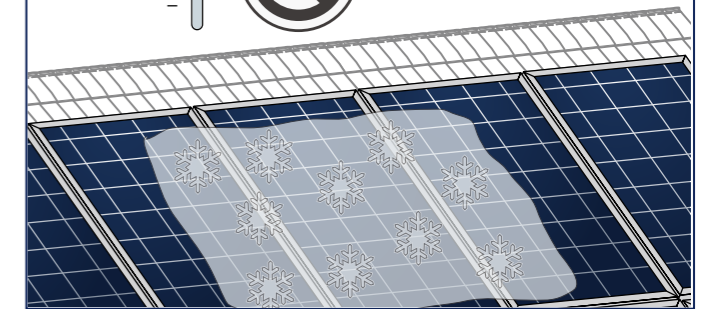
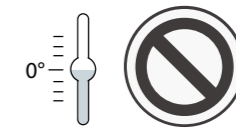

- Free the substructure from any dirt and debris (leaves, bird nests, etc.).

