Installation and Operation Manual

Q.TRON AC

Q.TRON BLK M-G2+ / AC SOLAR MODULE SERIES

Table of contents



1 Safety	3
Important Safety Instructions	3
2 Introduction	7
3 Planning	9
3.1 Technical Specifications	9
3.2 The Qcells AC System	14
3.3 Requirements	16
3.4 AC Module Planning	17
3.5 Mounting Options	20
3.6 Electrical Installation	28
4 Installation	34
4.1 Safety and Transport	34
4.2 Preparation of Installation	36
4.3 Module Installation	37
5 Electrical Connection	38
5.1 Safety	38
5.2 Connection of Modules	40
5.3 After Installation	41
6 Grounding	42
7 Faults and Defects	44
8 Disposal	44
9 Maintenance and Cleaning	45
10 Sample Wiring Diagram – Single Phase	46
11 Array & Mapping with Q.OMMAND PRO	47
11.1 Q.OMMAND PRO App	47
11.2 Q.OMMAND PRO Web	47
11.3 Q.OMMAND PRO Manual	47
12 Trouble Shooting Guide	48
13 Installation Map	49

DOCUMENT REVISION 01

This Manual is valid for North America as of September 1st 2024 for Q.TRON (BLK) M-G2/AC solar modules, and replaces all earlier versions.

This manual is subject to change. The data sheets and customer information valid at the point in time when the relevant module was manufactured apply to the installation, mounting, and maintenance procedures for the respective solar modules, as far as no updated document is provided.

1 Safety

IMPORTANT SAFETY INSTRUCTIONS

SAVE THESE INSTRUCTIONS – This manual contains important instructions for models Q.TRON BLK M-G2+ that shall be followed during installation and maintenance of the Q.HOME SMART system.

IMPORTANT: Interconnection of the Qcells AC Modules requires the AC Cable accessory product, which is not provided with the AC Modules.

Product Labels

The following symbols appear on the product label and are described here:



DANGER: Refer to safety instruction. Risk of electrical shock.





WARNING: Hot surface.







Refer to the manual.

Safety Symbols

Safety Symbol	Description
	Failure to comply with these instructions may cause severe injury or death.
	Failure to comply with the instructions may cause death or severe injury or property damage or immediate death caused by electricity.

Circuit Symbols

Circuit symbol	Description
	DC current supply. Generated from PV module.
	AC current supply. Generated from utility and micro inverter. Used in electric appliances.
	Symbol representing the phase of AC current. Mark the number in front of this symbol to represent the number of phases.
	Equipment Grounding Conductor (EGC). Conductor connecting normally non-current carrying metal parts of equipment together.
	Grounding Electrode Conductor (GEC). The conductor connecting the system to a grounding electrode system.

1 Safety

IMPORTANT SAFETY INSTRUCTIONS

DANGER

- To prevent the risk of electric shock, do not touch any terminals in operation and wait for a few minutes after turning a circuit breaker off. It may retain some stored energy for a short period following electrical isolation.
- To prevent the risk of arcing, do not disconnect the cable connector during operation.
- Do not contact electrically active parts of the panel, such as terminals, without appropriate safety gear. Contact may result in lethal spark or electric shock.
- To prevent the risk of electric shock, do not touch the glass surface or frame of the solar module after installation.
- Do not use or install AC modules if the module is broken or torn. Failure to comply may result in electric shock.

WARNING

- To prevent the risk of burns, do not touch AC modules during operation.
- Only qualified personnel should service modules.
- Damaged modules must be handled with proper PPE (Personal Protective Equipment).
- Q.TRON BLK M-G2 warranty is void if the microinverter cover has been removed. Refer to qualified personnel for service.
- For proper operation, make sure to use AC cables, connectors and accessories provided by Qcells. Parts that are not listed may cause critical danger.
- For proper operation, the AC module shall be connected only to a dedicated branch circuit connected to the Q.HOME COMBINER.
- To prevent the risk of fire, do not connect any load between an AC Modules' branch circuit and the circuit breaker in the Q.HOME COMBINER.
- Before installation, make sure to check that the installation location meets the required environmental conditions.
- Perform all work in dry conditions and use only dry tools. Do not handle wet panels without appropriate protection equipment.
- Do not come within reach of a broken or damaged module unless you are an authorized or qualified expert.
- Do not sharply bend AC Cables. Under stress, damage to the module conductor may occur. Maintain cable bend radius $\geq 5 \times$ the cable diameter at minimum.
- Do not bend AC cables. While under stress, it may occur module damage. Cable bending radius should be more than 5 times the cable diameter, at least.

PV rapid shutdown equipment (PVRSE)

This product has the function of PV rapid shutdown and is UL Listed as PV Rapid Shut Down Equipment and conforms to nationally recognized safety standards.

WARNING



- This photovoltaic rapid shutdown equipment (PVRSE) does not perform all of the functions of a complete photovoltaic rapid shutdown system (PVRSS).
- This PVRSE must be installed with other equipment to form a complete PVRSS that meets the requirements of NEC (NFPA 70) section 690.12 for controlled conductors outside the array. Other equipment installed in or on this PV system may adversely affect the operation of the PVRSS. It is the responsibility of the installer to ensure that the completed PV system meets the rapid shut down functional requirements. This equipment must be installed according to the manufacturer's installation instructions.

- This equipment shall be installed and operated in an environment within the ratings and limitations of the equipment as published in these installation instructions.

“PHOTOVOLTAIC SYSTEM EQUIPPED WITH RAPID SHUTDOWN”. The term “PHOTOVOLTAIC” may be replaced with ‘PV’.

1 Safety

IMPORTANT SAFETY INSTRUCTIONS

CAUTION

- Use proper equipment, connectors, wires and racking for the installation of the module.
- To reduce the risk of accidents, install the AC modules during mild weather.
- To reduce risk of injury or damage to the equipment, do not apply pressure on the module (ex. placing heavy objects or stepping on the module).
- To reduce risk of injury or damage to the equipment, do not drop the module. Modules must be gently handled and placed down with care.
- For proper operation, do not scratch the coating surface of the frame. It may increase the corrosion of the frame.
- For proper operation, do not artificially concentrate sunlight on the module surface.
- Addition of holes in the frame or glass of the module may decrease the strength and integrity of the frame or glass.
- Do not remove warning labels. Do not remove the labels attached on the module except the detachable QR-Code sticker for system mapping.
- Do not apply a shock to micro inverter of the module or pull the AC cable.
- Maintain the modules in their original packaging until installation. If unpacking is required for temporary storage, ensure disconnected modules are stored safely in a dry location where they will not be damaged.
- Do not allow AC Modules to come in contact with petroleum based products (oil or gasoline), as they damage the protective coating of the glass or frame.



- AC modules shall be mounted with racking and mounting products certified and listed for system fire class rating in accordance with UL1703 edition 2014 and UL2703 edition 2014.
- The System Fire Class Rating of the module or panel in a mounting system in combination with a roof covering must meet the requirements to achieve the specified System Fire Class Rating for a non-BIPV module or panel.
- "AC Modules must be installed ≥ 4 " from the roof surface to ensure adequate air circulation along the backside of the module. Installing the "AC Modules ≤ 4 " from the roof surface will violate their UL listing and fire class.
- The fire resistance of the AC Module is class C according to ANSI/UL790. Only roof-mount the AC modules over a fire-resistant roof.
- Verify and follow all local authorities' safety and installation guidelines.



- Both AC and DC voltage sources are terminated inside this equipment.
- Each circuit must be individually disconnected before servicing.
- When the photovoltaic array is exposed to light, it supplies a DC voltage to this equipment.
- AC Module arrays may only be connected to dedicated branch circuits in the Q.HOME COMBINER.

1 Safety

FCC Guideline

For Q.HOME SMART : Q.TRON AC and Q.HOME COMBINER

You are cautioned that changes or modifications to this unit not expressly approved by the party responsible for compliance could void the user's authority to operate this equipment.

This equipment has been tested and found to comply with the limits for a Class B Digital Device, pursuant to Part 15 of the FCC Rules. These limits are designed to provide reasonable protection against harmful interference in a residential installation. This equipment generates, uses and can radiate radio frequency energy and, if not installed and used in accordance with the instruction, may cause harmful interference to radio communication. However, there is no guarantee that interference will not occur in a particular installation. If this equipment does cause harmful interference to radio or television reception, which can be determined by turning the equipment off and on, the user is encouraged to try to correct the interference by one or more of the following measures :

- Reorient or relocate the receiving antenna.
- Increase the separation between the equipment and receiver.
- Connect the equipment into an outlet on a circuit different from that to which the receiver is connected.
- Consult the dealer or an experienced radio/TV technician for help.
- This device complies with part 15 of the FCC rules. Operation is subject to the following two conditions:

1. This device may not cause harmful interference, and
2. This device must accept any interference received, including interference that may cause undesired operation.

2 Introduction

With solar modules from Hanwha Q CELLS America Inc. (hereafter referred to as “Qcells”) you can directly transform the sun’s limitless energy into environmentally-friendly solar electricity. In order to ensure the maximum performance of your Qcells solar modules, please read the following instructions completely and carefully and observe all guidelines. Non-compliance may result in damage and/or physical injury.

This installation manual provides instructions for the safe installation and operation of crystalline solar modules.

- ➔ Read these instructions carefully before proceeding with your installation.
- ➔ Retain these instructions for the life of the solar modules.
- ➔ Ensure that this Manual is available to the operator at all times.
- ➔ This manual (and all supplementary information provided by the manufacturer) should be shared to any subsequent owners (or users) of the solar modules when ownership is transferred.
- ➔ Observe all applicable guidelines provided in documentation associated with overall system's operation.
- ➔ If your questions are not satisfactorily answered in the manual, please contact your system installer, or Qcells' Customer Support.

Additional information can be found on our website at www.qcells.com/us

Intended Use

This manual is valid in North America for Qcells solar modules. This manual is valid in North America for Qcells AC modules. These instructions contain information regarding the safe handling, installation, mounting, wiring, maintenance and use of quality crystalline solar modules from Qcells.

Symbols and Labels

The following symbols and labels are used throughout the Manual for ease of use.

SYMBOL	DESCRIPTION
➔	Procedure with one or more steps.
▪	Lists of items.
✔	Ensure that when carrying out a procedure, you check the results of said procedure.
⊘	Prohibited.



Beware of possible danger or damage. Categories:

- Danger: Risk of fatal injury
- Attention: Risk of serious injury or damage to property
- Note: Risk of damage to product

Units

Where both Metric and Imperial (US units for example inches) are shown, metric units are definitive. References to “Data Sheet” or “Module Data Sheet” refer to the Module Data Sheet applicable to the module being used.

Safety Regulations

The installer and homeowner or system owner are responsible for compliance with all applicable statutory requirements and regulations.

- ➔ The following regulations and standards must be upheld at all times during the installation, operation, and maintenance of the solar modules:
 - All instructions and guidelines provided in this Installation and Operation Manual.
 - Other applicable documents (such as country-specific regulations for operational safety, hazardous goods, and environmental protection).
 - Applicable country-specific laws, regulations, and provisions governing the planning, installation, and operation of solar power systems and work done on roofs.
 - Any valid international, national and regional regulations governing work with direct current, especially those applicable to the installation of electrical devices and systems, and regulations issued by the respective energy provider governing the parallel operation of solar power systems.
 - Accident-prevention regulations.

Verified Personnel

Both the owner and installer are responsible for ensuring that the installation, maintenance, connection to the grid, and any subsequent dismantling and removal are carried out by trained and qualified electricians or engineers with approved training certificates (issued by a state or federal organization) for their respective specialist trade. Electrical work may only be performed by an officially certified trader in accordance with the applicable safety requirements, accident prevention guidelines and the regulations of the local energy provider.

2 Introduction

Validity

These instructions are only valid for Q.TRON BLK M-G2+/AC from the company Qcells as specified at chapter "3.1 Technical Specifications". Qcells assumes no liability for damage resulting from failure to observe these instructions.

- To promote the sustainable reuse of material resources, recycle this product properly to prevent possible contamination of the environment or risk to human health.
- Please observe the instructions for any other system components that may be part of the complete solar power system. It may be necessary to carry out a structural analysis for the entire project.
- If your questions are not satisfactorily answered in the manual, please contact your system installer, or Qcells Customer Support. Additional information can be found on our website at www.qcells.com/us

Information for the Operator

- Please keep this manual for the entire life of the system.
- Please contact your system installer for information concerning the formal requirements for solar power systems.
- Please be sure to contact the relevant local authorities and energy providers regarding regulations and permit requirements prior to installation of the system.

Other applicable documents

Document type
Product data sheet
Packaging and transport information

MISUSE OR INCORRECT USE OF SOLAR MODULES VOIDS THE LIMITED WARRANTY AND MAY CREATE A SAFETY HAZARD OR RISK PROPERTY DAMAGE. THIS INCLUDES IMPROPER INSTALLATION OR CONFIGURATION, IMPROPER MAINTENANCE, UNINTENDED USE, AND UNAUTHORIZED MODIFICATION.



Attention!

This marking indicates that this product should not be disposed of with other household waste within the North America. Recycle this product properly to prevent possible damage to the environment or a risk to human health via uncontrolled waste disposal and in order to promote the sustainable reuse of material resources. Please return your used product to an appropriate collection point or contact the retailer where you purchased this product. Your retailer will accept used products and return them to an environmentally-sound recycling facility.



3 Planning

3.1 Technical Specifications

For additional information see the relevant datasheet of the module provided at www.qcells.com/us.

PRODUCT LINE	Q.TRON BLK M-G2+ / AC
Type	Q.ANTUM NEO
Length [in]	67.8 (1722 mm)
Width [in]	44.6 (1134 mm)
Frame height [in]	1.57 (40 mm)
Area [yd ²]	2.3 (1.953 m ²)
Weight [lbs]	50.6 lbs (23 kg)
Cable	4 mm ² Solar cable; (+) ≥ 25.8 in (655 mm), (-) ≥ 25.2 in (640 mm)
Max. system voltage V _{sys}	1000 V
Max. series fuse rating	25 A
Permissible temperature range ²	-40 °F to +140 °F (-40 °C to +60 °C)
Junction box protection class	≥ IP67 with bypass diode
Connector protection class	IP68
Fire rating based on ANSI/UL 61730	C/Type 2
Max. test load Push/Pull ³ [lbs/ft ²]	169/113 (8,100 Pa/5,400 Pa)
Max. design load Push/Pull ³ [lbs/ft ²]	113/75 (5,400 Pa/3,600 Pa)
Cerificates (Base DC module-Q.TRON BLK M-G2+)	CE-compliant; IEC 61215:2016; IEC 61730:2016; PV module classification: Class II; QCPV
Cerificates (AC module-Q.TRON BLK M-G2+ / Ac)	UL 1741, CSA C22.2 No.107
PV module classification	Class II
PV Array Configuration	1 × 1 ungrounded array; No additional DC side protection required; AC side protection requires max 20A OCPD per branch circuit.

¹ Weight includes Microinverter(Q.MI.349B-G1 (Model Name)).

² According to the Q.MI.349B-G1 (Model Name), the maximum temperature is stated as “60 °C (+140 °F)”, but the maximum temperature of the connected DC module is up to “+85 °C (+185 °F)”.

³ Test and design load in accordance with IEC 61215:2016, depending on mounting options (see section "3.5 Mounting Options")

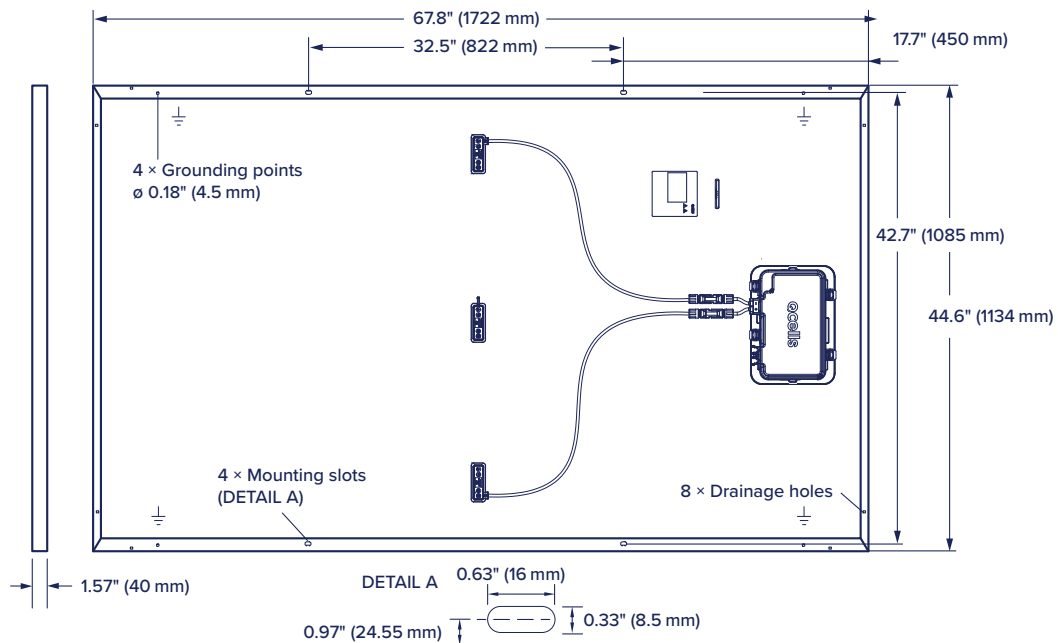

Fig. 1: External dimensions (in inch (mm)) and components for Q.TRON (BLK) M-G2 / AC

3 Planning

3.1 Technical Specifications

AC PARAMETERS				
Max Continuous AC Output Power (-40 °C to +60 °C)	VA			349
Peak Output Power	VA			366
Power Factor (adjustable)				0.85 leading ... 0.85 lagging
Nominal AC Output Voltage Range ¹ (single phase)	V _{rms}	211	240	264
Nominal Output Current 240 VAC (single phase)	A			1.45
Nominal Frequency	Hz	59.3	60	60.5
Extended Frequency Range	Hz	50		66
Max AC Output over Current Protection Device	A			20
AC short circuit fault current over 3 cycles	A			2
AC Port Backfeed Current under Single Fault	A			0
Power Factor at Rated Power				1.0

¹ Nominal Voltage Range can be extended if required by the utility. Utility interconnection voltage and frequency trip comply with UL1741, UL1547

3 Planning

3.1 Technical Specifications

Topic	Unit	Min	Typical	Max
MISCELLANEOUS PARAMETERS				
Maximum Microinverters per 20 A Branch Circuit 240 VAC	A		11	
CEC weighted efficiency 240 VAC	%		97	97.3
Total Harmonic Distortion	%			5
Ambient Temperature Range [°F]	°F (°C)	-40°F (-40°C)		+140°F (+60°C)
Night Tare Loss	mW			60
Storage Temperature Range [°F]	°F (°C)	-40°F (-40°C)		+176°F (+80°C)
FEATURES AND SPECIFICATIONS				
Dimensions (inc. Bracket) [W × H × D] [in]	10.4 × 7.5 × 1.2 (263.7mm × 191.5mm × 31.6mm)			
Connector Type	MC4			
Weight [lb]	3.2lb (1.5kg)			
Torque Specifications for fasteners (Do not over torque) [in]	<ul style="list-style-type: none"> ■ 0.236 in (6 mm) mounting hardware: 5 Nm ■ 0.315 in (8 mm) mounting hardware: 9 Nm ■ When using earthing hardware, use the manufacturer's recommended torque value 			
Cooling	Natural convection - no fans			
Product Warranty/ Performance Warranty (Year)	25			
Enclosure	Class II double-insulated			
Country of Manufacturer	USA			
Relative Humidity Range	4% to 100% condensing			
Approved for Wet Locations	Yes			
Maximum Altitude [ft]	13,123 ft (4000 meters)			
Certificates and approvals	This product is UL Listed as PV Rapid Shut Down Equipment and conforms to nationally recognized safety and sustainability standards. UL 1741, UL 1741SA, UL 1741SB with HECO 14H and CA rule 21, IEEE 1547-2020, IEEE 2030.5, FCC Part 15 Class B, CSA C22.2 NO. 107.1-01, UL 1998, UL 991			
Monitoring (Mobile App/Web)	Q.OMMAND Energy Management System monitoring portal			
Communication	PLC (power line communication)			

3 Planning

3.1 Technical Specifications

Qcells AC Cable

SPECIFICATION	VALUE
Voltage Rating	600 VAC
Voltage Withstand Test (kV/1 min)	2 KV
Max DC Conductor Resistance (68°F (20°C)) (Ω / km)	8.74 (5.43 Ω / km)
System Temperature Range (ambient)	-40°F to +140°F (-40°C to +60°C)
Cable temperature Rating	194°F (90°C) Dry/194°F (90°C) Wet
Cable Rating	DG, TC, TC-ER
Certification	E533140, 350652
Flame Rating	FT4
Cable Conductor Insulator Rating	194°F (90°C)/600 V
Environmental Protection Rating	IP68
UV Resistance	UL3003
Compliance	RoHS, OIL RES I, CE, UV Resistant

Qcells Connector Ratings

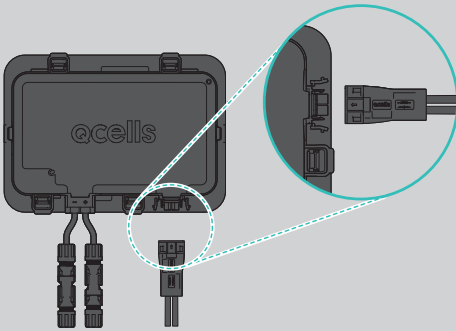
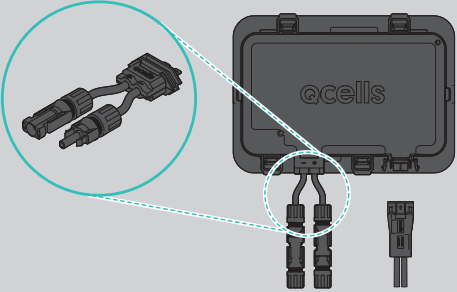
MODEL	MAXIMUM VOLTAGE
MI-AC T Block Female 	288 VAC
MI-DC Connector Assy 	60 VDC



NOTE!





Only Qcells connectors/AC cables are permitted.

3 Planning

3.1 Technical Specifications

Required Accessories

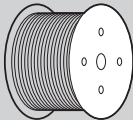
Qcells Accessories*

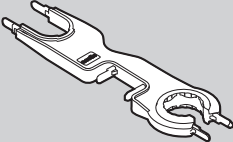
PART	MODEL	MAXIMUM VOLTAGE
AC Cable	CAS-HQ-LO-1000 	Long AC Cable (L=1000 mm): 1000 mm long cable. Intended for use connection landscape oriented PV modules.
	CAS-HQ-SH-650 	Short AC Cable (L=650 mm): 650 mm long cable. Intended for use connecting portrait oriented PV modules.
Cable Connection Kit	CAB-HQ-KIT-200 	AC cable spool : 200 m (656 ft) of cable (no connectors) for inter-array jumpers and home run lines.
	CON-HQ-KIT-20 	AC Connector : used to assemble inter-array jumpers and home run lines using AC cable spool. - Package : 20pcs/ea, Male/Female
	ECAP-HQ-KIT-20 	End cap: to close the end of PV string - package: 20 pcs Female + 20 pcs Male
Unlocking Tool	UNT-HQ-TOOL-G1 	Unlocking tool

Tools

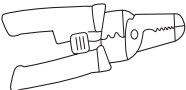
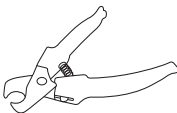
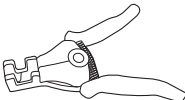
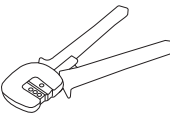
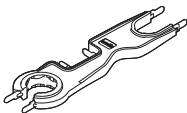
Branching pliers	wire scissor	Strip clamp	Crimping tool	Connector tool
				

* Accessories listed are separate Qcells products which must be used in conjunction with these products to maintain code and standard compliance.

3 Planning

3.2 The Qcells AC System

The Qcells AC Module System includes:

Grid supporting, utility interactive microinverters convert the DC output of the PV module into grid-compliant AC power.

- Qcells Q.HOME COMBINER is a communication device that provides network access to the PV array. Q.HOME COMBINER collects production and performance data from the Qcells AC Module over on-site AC power lines and transmits the data to Web/App monitoring through an Internet or cellular connection. Q.HOME COMBINER is capable of monitoring up to 144 Qcells AC Module. For details, refer to Q.HOME COMBINER Installation and Operations Manual.
- Q.OMMAND Energy Management System is Web/App monitoring and management software. Installers can use Web/App monitoring to view detailed performance data, manage multiple PV systems, and remotely resolve issues that might impact system performance. Find out more informations by contacting call center. Call Center: +1 (888) 249-7750
- Qcells mobile app for iOS and Android devices. It allows installers to configure the system while onsite, eliminating the need for a laptop and improving installation efficiency. You can use the app to:
 - Connect to the Qcells Q.HOME COMBINER over a wireless network for faster system setup and verification.
 - View and email a summary report that confirms a successful installation.
 - Scan device serial numbers and sync system information with Q.OMMAND.
- Qcells Field Wireable connectors CON-HQ-KIT-20 makes connections from Qcells' AC Cable, or open Field Wireable connector.

This manual describes the safe installation and operation of the Qcells AC Module.



NOTE!

To ensure optimal reliability and to meet warranty requirements, the Qcells AC Module must be installed according to the instructions in this manual.

How the Qcells AC Module Works

Each AC Module includes an integrated microinverter which maximizes energy production by using a sophisticated maximum power point tracking (MPPT) algorithm at each individual module ensuring each module produces as much energy as it can.

3 Planning

3.2 The Qcells AC System

Inspecting Components of an AC Module

After receiving products, inspect all parts for possible deformity or malfunction.

- Q.TRON BLK M-G2+/AC (AC module)

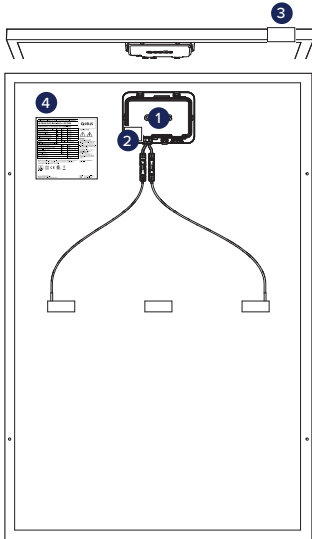

1. Q.MI.349B-G1 (Model Name) (Microinverter)
Converts DC power generated by each PV module to AC power.
2. Detachable ID Label
Installer to place it on a map and scan for record and physical layout generation.
3. Module Serial no. Label
Customer can scan it for array mapping.
4. Product Label
Indicates product specification and ID number.

- Accessory (Contact Qcells for order)

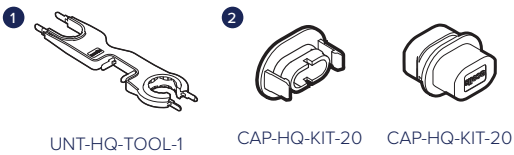

1. Unlocking Tool
For handling male and female connectors.
2. Male/Female End Cap
Is for sealing a Male/Female connector.

- Cable Connection Kit

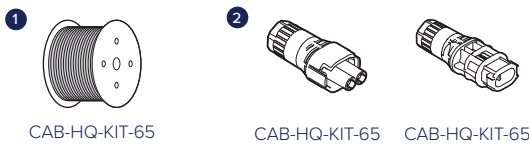

1. AC Cable(RAW)
Is for raw cable for assembly.
2. Male/Female AC Connector
Is for Male/Female AC connector assembly.

Microinverter Topology

This Microinverter Topology enables an individual Maximum Power Point Tracker (MPPT) to control each AC module, ensuring that maximum power available from each AC module is generated regardless of the performance of the other AC modules in the array. While an individual AC module in the array may be affected by shading, soiling, orientation, or AC module mismatch, each Qcells AC module ensures top performance for its associated PV module.

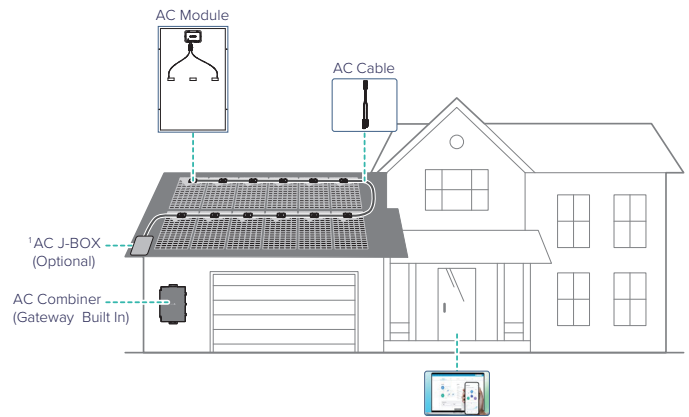

¹AC junction box is option and voluntarily determined to be installed based on installer decision (Optional)

Q.OMMAND PRO / HOME App & Web

System Monitoring

Once you install the Q.HOME Combiner and provide an internet connection through a broadband router or modem, the Qcells AC Module will automatically begin reporting to Q.OMMAND Energy Management system. Q.OMMAND display current and historical system performance trends and informs you of your system status.

Optimal Reliability

Qcells AC Module systems are inherently more reliable than traditional inverters. Qcells AC Modules are designed to operate at full power at ambient temperatures as high as 140°F (60°C).

Ease of Design

Qcells AC Module systems using Qcells Microinverters are very simple to design and install. Designers will not need to perform cumbersome calculations like those required in systems utilizing traditional string inverters.

Low voltage DC wires connect from the PV module directly to the co-located microinverter, eliminating the risk of personnel exposure to dangerously high DC voltage.

3 Planning

3.3 Requirements

Installation Site

Please note the following guidelines that apply to the installation site:

- Solar modules are not explosion-proof and are not suitable for use in explosive environments.
- Do not operate solar modules near highly flammable gas and vapors (e.g. gas tanks, gas stations).
- Do not install modules in an enclosed space.
- Do not install modules in locations where they may be submerged in water (e.g. floodplains).
- Do not use modules as a substitute for the normal roofing (e.g. modules are not watertight).
- Do not install modules in close proximity to air conditioning systems.
- Do not install modules above 13,120ft (4,000m) altitude above sea level.
- Contact with saline water (e.g. spray water from the sea) and salt aggregation on the modules must be avoided.
- Do not bring any chemical substance (e.g. oil, solvent etc.) into contact with any part of the panel. Only substances, which are released by Qcells, are allowed to be used during installation, operation and maintenance.
- Any installation of modules on surfaces of water is prohibited. This includes installations on floating as well as pile-based platforms. Qcells may extend the coverage of its warranty to such installations, based on a case by case assessment of the system design and location. A prior written consent by the warrantor is required in any case.

Prevention of Shading Effects

Optimal solar irradiation leads to maximum energy output:

- For this reason, install the modules so that they face the sun.
- Avoid shading (due to objects such as buildings, chimneys or trees).
- Avoid partial shading (for example through overhead lines, dirt, snow).

Limitations

The solar modules are designed for the following applications:

- Operating temperatures from -40°F to $+140^{\circ}\text{F}$.
- Pull loads and push loads according to chapter 2.3 ('Test Load' in accordance with IEC 61215 and 'Design Load $\times 1.5$ ' in accordance with UL 61730).
- Installation using a mounting structure for solar modules.

Mounting Structure Requirements

Requirements for the mounting structure:

- Conform to the necessary structural requirements.
- Compliant with local snow and wind loads.
- Properly fastened to the ground, roof or façade.
- Forces acting on the module are relayed to the mounting sub-structure.
- Ensures sufficient rear ventilation of the module.
- Avoid the usage of different metals to prevent contact corrosion.
- Allows for stress-free expansion and contraction due to temperature fluctuations.

- Ensure that no additional forces are applied through the mounting system into the module except for the wind and snow loads. Additional forces and moments of torque at the mounting positions caused by torsions, displacements or vibrations in the mounting system are not allowed.
- Ensure that the clamps and the mounting frame are compatible.

Clamp System Recommendations

Use customary clamps that satisfy the following requirements:

- Clamp width: ≥ 1.57 in (40 mm).
- Clamp height compliant with a 1.57 in (40 mm) frame height.
- Clamp depth: 0.28-0.47 in (7-12 mm). (applicable for all CL clamping mounting options at section "3.5 Mounting Options")
- Clamps are not in contact with the front glass.
- Clamps do not deform the frame.
- Clamps that satisfy the structural requirements based on the conditions of the installation site according to the applicable regulations and technical standards.
- Long-term stable clamps that securely affix the module to the mounting frame.

Module Orientation Requirements

- Vertical or horizontal installation is permitted.
- Ensure that rain and melting snow can run off freely. No water accumulation.
- Ensure that the drainage holes in the frame are not covered. No sealing.

→ Maintain the permissible angle of inclination.

- Minimum angle of inclination: 3°
- Inclination angles above 75° may be limited by local regulations

→ Standing water on the modules' glass needs to be avoided.

→ Ensure that all the drainage holes in the frame are not covered.

3 Planning

3.4 AC Module Planning

Installation Site

Housing of the microinverter is designed for outdoor installation and complies with the IP67 environmental enclosure rating standard:



NOTE!
IP67 rating definition:

- The IP67 environmental rating indicates that a solar module is highly resistant to dust and water ingress. The "IP" stands for "Ingress Protection", with the first digit "6" signifying complete protection against dust, and the second digit "7" indicating that the module can withstand temporary immersion in water up to 1 meter deep for 30 minutes. This rating ensures that the solar module can operate reliably in harsh outdoor conditions.
- The Qcells AC Cable is available in two conductor length options for landscape and portrait orientations.



NOTE!

- Some Qcells AC Module will not begin exporting power until the Gateway is installed and has detected all the microinverters at the site. In addition, the grid profile may need to be configured, and the Q.HOME COMBINER must have propagated these settings to the microinverters. For instructions on this procedure, refer to the Q.HOME COMBINER Installation and Operation Manual.

Grounding Considerations

The Qcells Microinverter do not require grounding electrode conductors (GEC) or equipment grounding conductors (EGC). Your Authority Having Jurisdiction (AHJ) may require you to bond the mounting bracket to the racking. If so, use earthing hardware or star washers. The microinverter itself has a Class II double-insulated rating, which includes ground fault protection (GFP).

Branch Circuit Capacity

Plan your AC branch circuits to meet the following limits* for maximum number of AC Module per branch when protected with a 20A over-current protection device (OCPD).

PER SINGLE AC BRANCH CIRCUIT*
11EA
TOTAL AC BRANCH CIRCUIT*
44EA

Utility Service Requirements

The Qcells AC Module work with single-phase service. Measure AC line voltage at the electrical utility connection to confirm that it is within range:

SINGLE-PHASE SERVICE	
L1 to L2	211 to 264 VAC

Wire Lengths and Voltage Rise

When planning the system, you must select the appropriate AC conductor size to minimize voltage rise. Select the correct wire size based on the distance from the beginning of the microinverter AC branch circuit to the breaker in the load center. Qcells recommends a voltage rise total of less than 2% for the sections from the microinverter AC branch circuit to the breaker in the load center.



NOTE!

- Protection against lightning and resulting voltage surge must be in accordance with local standards.

→ Lightning and Surge Protection

Surge protection of AC module system is recommended. Surge is a harmful factor that occurs environmentally, such as lightning, motors, and electrical appliances. Protection from lightning and overvoltage surges may be required for various reasons. A surge protection device (SPD) may be necessary or required when installed on some types of buildings.

→ Surge protection

The AC Module has a built-in surge protection circuit. However, the device may be damaged if an external surge occurs that exceeds the built-in protection function. The microinverter's surge protection circuit is designed to work for a surge. So it is recommended to protect your system with SPD lightning or excess energy.

3 Planning

3.4 AC Module Planning

Parts and Tools Required

In addition to the microinverters, PV modules, and racking, you will need the following:

Qcells Equipment

- Qcells Q.HOME COMBINER is required to commission the system and monitor solar production. For installation information, refer to the Q.HOME COMBINER Installation and Operations Manual.
- Qcells Installer mobile Apps: Download the Qcells Installer mobile app and open it to log in to your web account.
- Search and install Q.OMMAND PRO on the Apple AppStore or Google Play Store.



Android



iOS

The app runs with the following versions or higher.
Check OS version of the mobile device.

- Android: 6.0 or higher
- iOS: 11.0 or higher
- Q.TRON AC
- Qcells Accessories (Long/Short AC Cable, Cable Connection Kit, Unlocking Kit) - Refers to 13 page.

Q.OMMAND PRO Manual

- Scan the QR code below to access to Q.OMMAND PRO manual.



3 Planning

3.4 AC Module Planning

Qcells AC Cable

CABLE MODEL	CONNECTOR LENGTH	PV MODULE ORIENTATION	CONNECTOR COUNT PER BOX
AC Cable Short	25.29in (0.65 m)	Portrait	50
AC Cable Long	39.37in (1.0 m)	Landscape	50

3 Planning

3.5 Mounting Options

REQUIREMENTS OF ALL MOUNTING OPTIONS

- The loads in the table are related to the mechanical stability of the solar modules. The mechanical stability of the mounting system including clamps has to be evaluated by the Qcells. The listed test load values have been determined with the following clamp parameters: clamp width = 1.57 in (40 mm) and clamp depth = 0.39 in (10 mm).
- The system installer is responsible for the determination of location-specific load requirements.
- Modules bend under load. Therefore, sharp objects (e.g. screws, ballast stones, rail ends, rails with burrs or sharp corners) must not be placed near the module backside so as not to touch the laminate under load.
- Ensure that the junction boxes do not touch the mounting structure (e.g. shorts rails, ballast, etc.) or the rooftop under load.
- Clamps or insertion profiles etc. must not touch the glass (even under load).
- Unbalanced loads (e.g. snow overhangs, snowdrifts) which result in locally significantly increased loads must be removed or avoided by technical measures.

Loads according to IEC 61215-2:2016 and UL 61730-2:2017 except for design loads lower than 1600 Pa which do not fulfill the requirements of the standards. The test procedure is always according to IEC 61215-2:2016. Design loads result from the safety factor 1.5.

Mounting options with Clamps

The illustrate installation options apply for both horizontal and vertical module orientation



4 CLAMPS ON LONG SIDE & 2 CONTINUOUS RAULS PARALLEL TO SHORT SIDE

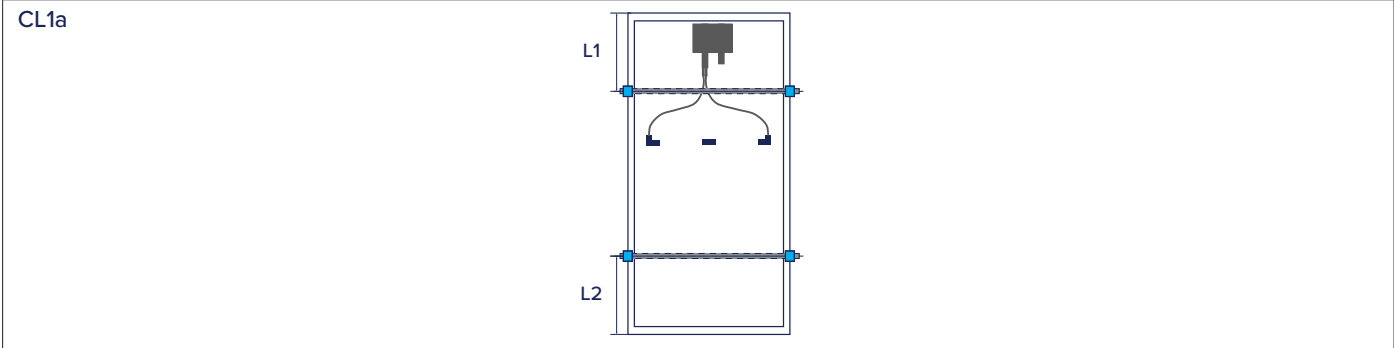

		POSITION OF CLAMPS* [in]	TEST LOAD PUSH/PULL [Pa]	DESIEN LOAD PUSH/PULL [Pa]
V1	L1	0.79 - 1.97 (20 - 50 mm)	3600/3600	2400/2400
	L2	5.91 - 11.8 (20 - 600 mm)		
V2	L1	0.79 - 1.97 (20 - 50 mm)	6000/4400	4000/2930
	L2	9.84 - 17.7 (250 - 450 mm)		
V3	L1	17.3 - 23.6 (440 - 600 mm)	6000/3200	4000/2130
	L2	0.79 - 23.8 (20 - 600 mm)		
V4	L1	0.79 - 1.97 (20 - 50 mm)	5400/5400	3600/3600
	L2	7.87 - 11.8 (200 - 300 mm)		

CL1a → Ensure that module frame is fixed directly on the rail of the substructure (no spacer allowed between the module and substructure).

* Distance between outer edge of module and middle of the clamp.

3 Planning

3.5 Mounting Options

4 CLAMPS ON LONG SIDE (SHORT RAIL ALLOWED)			
CL1b			
POSITION OF CLAMPS* [in]		TEST LOAD PUSH/PULL [Pa]	DESIGN LOAD PUSH/PULL [Pa]
L	7.87 - 13.8 (200 - 350 mm)	2600/3600	1730/2400
	0.79 - 21.6 (20 - 550 mm)	1600/2400	1060/1600
CL1a	<ul style="list-style-type: none"> → Minimum support depth of 15 mm is required on the back side of the module. → Short mounting rails are permissible, if they overlap with the module less than 210 mm. Maintain a minimum distance (clearance) of ≥ 35 mm between frame bottom edge and roof top or ballast. 		

4 CLAMPS ON SHORT SIDE & 2 CONTINUOUS RAILS PARALLEL TO LONG SIDE			
CL2a			
POSITION OF CLAMPS* [in]		TEST LOAD PUSH/PULL [Pa]	DESIGN LOAD PUSH/PULL [Pa]
S	0.79 - 5.12 (20 - 130 mm)	3600/2400	2400/1600
	0.79 - 13.8 (20 - 350 mm**)	3600/2000	2400/1330
CL2a	<ul style="list-style-type: none"> → Ensure that module frame is fixed directly on the rail of the substructure (no spacer allowed between the module and substructure). 		

* Distance between outer edge of module and middle of the clamp.

** Rail must not be under the junction box.

3 Planning

3.5 Mounting Options

4 CLAMPS ON SHORT SIDE			
CL2b			
POSITION OF CLAMPS* [in]		TEST LOAD PUSH/PULL [Pa]	DESIGN LOAD PUSH/PULL [Pa]
S	0.79 - 7.87 (20 - 200 mm)	2400/2400	1600/1600
CL2b	<ul style="list-style-type: none"> → Minimum support depth of 15 mm is required on the back side of the module. → Short mounting rails are permissible, if they overlap with the module less than 110 mm. Maintain a minimum distance (clearance) of ≥ 70 mm between frame bottom edge and roof top or ballast. 		

4 CLAMPS ON LONG SIDE & 2 CONTINUOUS RAULS UNDERNEATH LONG FRAME PARTS			
CL3			
POSITION OF CLAMPS* [in]		TEST LOAD PUSH/PULL [Pa]	DESIGN LOAD PUSH/PULL [Pa]
L	7.87 - 11.8 (200 - 300 mm)	4000/3600	2660/2400
CL2b	<ul style="list-style-type: none"> → Ensure that module frame is fixed directly on the rail of the substructure (no spacer allowed between the module and substructure). → Minimum support depth of 15 mm is required on the back side of the module. 		

* Distance between outer edge of module and middle of the clamp.

3 Planning

3.5 Mounting Options

2 CLAMPS ON LONG SIDE, 2 CLAMPS ON SHORT SIDE			
CL5			
POSITION OF CLAMPS* [in]		TEST LOAD PUSH/PULL [Pa]	DESIGN LOAD PUSH/PULL [Pa]
S	0.79 - 3.94 (20 - 100 mm)	3200/3200	2130/2130
L	11.8 - 17.7 (300 - 450 mm)		
CL5	→ Minimum required support depth on the module backside is 10 mm on long frame side and 15 mm on short frame side.		

6 CLAMPS ON LONG SIDE & 3 CONTINUOUS RAILS PARALLEL TO SHORT SIDE			
CL6a			
POSITION OF CLAMPS* [in]		TEST LOAD PUSH/PULL [Pa]	DESIGN LOAD PUSH/PULL [Pa]
L1	0.79 - 1.97 (20 - 50 mm)	8100/5400	5400/3600
L2	0.79 - 13.8 (20 - 350 mm)		
L3	22.1 - 32.3 (561 - 820 mm)		
CL6a	→ Ensure that module frame is fixed directly on the rail of the substructure (no spacer allowed between the module and substructure).		

* Distance between outer edge of module and middle of the clamp.

3 Planning

3.5 Mounting Options

6 CLAMPS ON LONG SIDE (SHORT RAILS ALLOWED)			
CL6c			
POSITION OF CLAMPS* [in]		TEST LOAD PUSH/PULL [Pa]	DESIGN LOAD PUSH/PULL [Pa]
L1	0.79 - 13.8 (20 - 350 mm)	3200/3200	2130/2130
L2	26.0 - 41.8 (661 - 1061 mm)		
CL6c	→ Short mounting rails are permissible, if they overlap with the module less than 200 mm. Maintain a minimum distance (clearance) of ≥ 40 mm between frame bottom edge and roof top or ballast.		

2 CLAMPS ON LONG SIDE, 4 CLAMPS ON SHORT SIDE			
CL6d			
POSITION OF CLAMPS* [in]		TEST LOAD PUSH/PULL [Pa]	DESIGN LOAD PUSH/PULL [Pa]
S	0.79 - 7.87 (20 - 200 mm)	3600/3600	2400/2400
L	26.0 - 41.8 (661 - 1061 mm)		
CL6d	→ Short mounting rails are permissible, if they overlap with the module less than 110 mm. Maintain a minimum distance (clearance) of ≥ 30 mm between frame bottom edge and roof top or ballast. → Minimum support depth of 15 mm is required on the back side of the module.		

* Distance between outer edge of module and middle of the clamp.

3 Planning

3.5 Mounting Options

Mounting options with bolts

The illustrate installation options apply for both horizontal and vertical module orientation.



4 BOLTS / SCREWS ON LONG SIDE & 2 CONTINUOUS RAILS PARALLEL TO SHORT SIDE				4 BOLTS / SCREWS ON LONG SIDE & 2 CONTINUOUS RAILS UNDERNEATH LONG FRAME PARTS			
FB1				FB2			
POSITION OF BOLTS [in]		TEST LOAD PUSH/PULL [Pa]	DESIGN LOAD [Pa]	POSITION OF BOLTS [in]		TEST LOAD PUSH/PULL [Pa]	DESIGN LOAD [Pa]
L	17.7 (450 mm)	6000/4000	4000/2665	L	17.7 (450 mm)	3700/4000	2460/2665
FB1, FB2		<ul style="list-style-type: none"> → Ensure that module frame is fixed directly on the rail of the substructure (no spacer allowed between the module and substructure). → Use M8 corrosion-proof screws and washers (diameter ≥ 15.8mm) for mounting slots (Detail A, Fig.1). Mounting screws and washers should have the same material properties. 					
FB2		<ul style="list-style-type: none"> → Minimum support depth of 15 mm is required on the back side of the module. 					

Mounting options with insertion profiles

The illustrated installation options apply for both horizontal and vertical module orientation.



INSERTION PROFILE ON LONG SIDE		4 INSERTION PROFILE ON SHORT SIDE	
IP1		IP2	
TEST LOAD PUSH/PULL [Pa]	DESIGN LOAD PUSH/PULL [Pa]	TEST LOAD PUSH/PULL [Pa]	DESIGN LOAD PUSH/PULL [Pa]
3600/3600	2400/2400	2400/2000	1600/1330
IP1, IP2		<ul style="list-style-type: none"> → Ensure minimum support depth of 15 mm on the backside and 10 mm on the front side of the module.. 	

3 Planning

3.5 Mounting Options

Specifications

MOUNTING OPTION	POSITION OF CLAMPS* [IN (MM)]	TEST LOAD PUSH/PULL** [PA]	DESIGN LOAD PUSH/PULL** [PA]
CL1a	MI side: 0.79 - 1.97 (20 - 50) Non-MI side: 0.79 - 23.6 (20 - 600)	3600/3600	2400/2400
	MI side: 0.79 - 1.97 (20 - 50) Non-MI side: 9.84 - 17.7 (250 - 450)	6000/4400	4000/2930
	MI side: 0.79 - 1.97 (20 - 50) Non-MI side: 7.87 - 11.8 (200 - 300)	5400/5400	3600/3600
	MI side: 17.3 - 23.6 (440 - 600) Non-MI side: 0.79 - 23.6 (20 - 600)	6000/3200	4000/2130
FB1	17.7 (450)	6000/4000	4000/2665
FB2	17.7 (450)	3700/4000	2460/2665
IP1	-	3600/3600	2400/2400
CL1b	7.87 - 13.8 (200 - 350)	2600/3600	1730/2400
CL2a	0.79 - 5.12** (20 - 130****)	3600/2400	2400/1600
CL2b	0.79 - 7.87 (20 - 200)	2400/2400	1600/1600
CL3	7.87 - 11.8 (200 - 300)	4000/3600	2660/2400
CL5	short side: 0.79 - 3.94 (20 - 100) long side: 11.8 - 17.7 (300 - 450)	3200/3200	2130/2130
CL6a	outer clamps: MI side: 0.79 - 1.97 (20 - 50) Non MI-side: 0.79 - 13.8 (20 - 350) middle clamps on the non-MI side: 22.1 - 32.3 (561 - 820)	8100/5400	5400/3600
CL6c	outer clamps: 0.79 - 13.8 (20 - 350) middle clamps: 26.0 - 41.8 (661 - 1061)	3200/3200	2130/2130
CL6d	short side: 0.79 - 7.87 (20 - 200) long side: 26.0 - 41.8 (661 - 1061)	3600/3600	2400/2400

MOUNTING OPTION	POSITION OF CLAMPS* [in]	TEST LOAD PUSH/PULL*** [Pa]	DESIGN LOAD PUSH/PULL*** [Pa]
CL1b	0.79 - 21.6 (20 - 550)	1600/2400	1060/1600
IP2	-	2400/2000	1600/1330
CL2a	0.79 - 13.8 (20 - 350****)	3600/2000	2400/1330

* Distance between outer edge of module and middle of the clamp; consider further details below.

** Loads according to IEC 61215-2:2016 and UL 61730-2:2017

*** Loads according to IEC 61215-2:2016 and UL 61730-2:2017 except for design loads lower than 1600Pa which do not fulfill the requirements of the standards.

**** Rails must not be under the junction box and microinverter.

Safety Factor is considered as 1.5.

3 Planning

3.5 Mounting Options

MOUNTING OPTIONS	REQUIREMENTS
All	<ul style="list-style-type: none"> → The loads in the table are related to the mechanical stability of the solar modules. Mounting system and installation equipment (clamps, etc.) are not part of the PV module certification acc. IEC 61215/61730. The mechanical stability of the mounting system including clamps has to be evaluated by the system installer. The listed test load values have been determined with special reusable test clamps with high stiffness in order to be able to apply maximum stress to the module components during the test. The installer has to make sure that the used clamps are capable of securely fastening the module under the specified maximum loads. → The system installer is responsible for the determination of location-specific load requirements. → Modules bend under load. Therefore, sharp objects (e.g. screws, ballast stones, rail ends, rails with burrs or sharp corners) must not be placed near the module backside so as not to touch the laminate under load. → Ensure that the junction boxes & microinverter do not touch the mounting structure (e.g. mounting rails, shorts rails, ballast, etc.) or the rooftop under load. Clamps or insertion profiles etc. must not touch the glass (even under load). → Unbalanced loads (e.g. snow overhangs, snowdrifts) which result in locally significantly increased loads must be removed or avoided by technical measures.
CL1a, CL2a, CL3, FB1, FB2, CL6a	<ul style="list-style-type: none"> → Ensure that module frame is fixed directly on the rail of the substructure (no spacer allowed between the module and substructure).
CL1b	<ul style="list-style-type: none"> → Short mounting rails are permissible, if they overlap with the module less than 8.27 in (210 mm). Maintain a minimum distance (clearance) of ≥ 1.38 in (35 mm) between frame bottom edge and roof top or ballast.
CL1b, CL2b, CL3, FB2, CL6c, CL6d	<ul style="list-style-type: none"> → Minimum support depth of 0.59 in (15 mm) is required on the back side of the module.
CL5	<ul style="list-style-type: none"> → Minimum required support depth on the module backside is 0.39 in (10 mm) on long frame side and 0.59 in (15 mm) on short frame side.
IP1, IP2	<ul style="list-style-type: none"> → Ensure minimum support depth of 0.59 in (15 mm) on the backside and 0.39 in (10 mm) on the front side of the module.
FB1, FB2	<ul style="list-style-type: none"> → Use M8 corrosion-proof screws and washers (diameter ≥ 0.62 in (15.8 mm)) for mounting slots (Detail A, Fig.1). Mounting screws and washers should have the same material properties.
CL2b	<ul style="list-style-type: none"> → Short mounting rails are permissible, if they overlap with the module less than 4.33 in (110 mm). Maintain a minimum distance (clearance) of ≥ 2.76 in (70 mm) between frame bottom edge and roof top or ballast.
CL6d	<ul style="list-style-type: none"> → Short mounting rails are permissible, if they overlap with the module less than 4.33 in (110 mm). Maintain a minimum distance (clearance) of ≥ 1.18 in (30 mm) between frame bottom edge and roof top or ballast.
CL6c	<ul style="list-style-type: none"> → Short mounting rails are permissible, if they overlap with the module less than 7.87 in (200 mm). Maintain a minimum distance (clearance) of ≥ 1.57 in (40 mm) between frame bottom edge and roof top or ballast.

3 Planning

3.6 Electrical Installation

Module AC Connection

Before pairing AC cable connectors, familiarize yourself with the following descriptions specifically explaining how to handle AC cable connectors and accessories.

- Insert the AC Cable T-Block connector into the Microinverter AC Connector.
- Insert the AC Cable female connector into the AC cable male connector in horizontal direction. If you insert at wrong angle, the connector can be damaged.
- Insert a connector fully into the end of the connector until you hear two clicks.
- When mating the connectors, ensure that coupling connectors is done by pushing the connectors together until two clear audible clicks are heard.
- When the connectors are correctly connected, there should be no space between the end of a male connector and the end of a female connector.
- Use the UNT-HQ-TOOL-1 to remove the connector. Do not use any other tools.
- The following unlocking tool is available for disconnecting the combined AC cable connectors.
- The male and female connectors will be opened by fully pressing the unlocking tool into the latches. (Refer to 3.6)
- After the unlocking tool insertion is complete, pull the connectors apart.

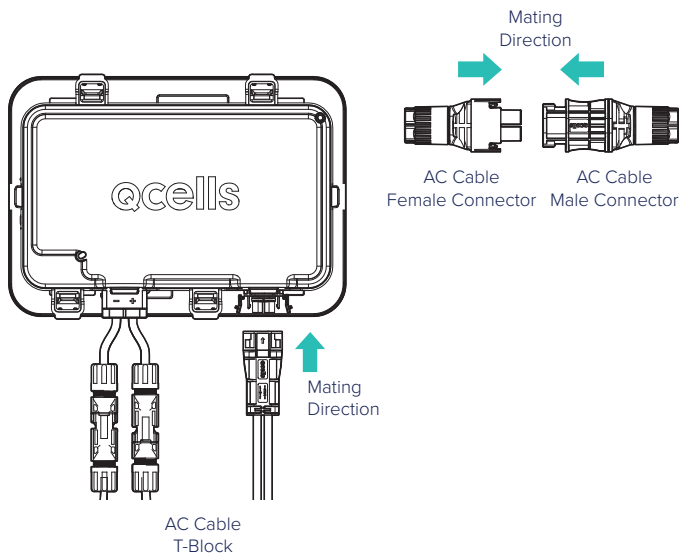

Attention!

- Do not let cable be pulled too tight or hang too loose. Internal conductor may break.
- Do not allow any liquid inside to prevent danger of electric shock.
- Do not use damaged cables.
- Do not cut or transform AC cables for use.
- Frequent disassembly or connection may damage connectors.
- The size of dedicated cables are decided by NEC2020.
- Do not bend the cable too many times. It may result in mechanical and/or electrical problems.
- Do not disconnect AC cable connectors under load.

There is a sample for AC output cables connection of single phase 240 VAC below.

The Microinverter is compatible with 240 VAC.

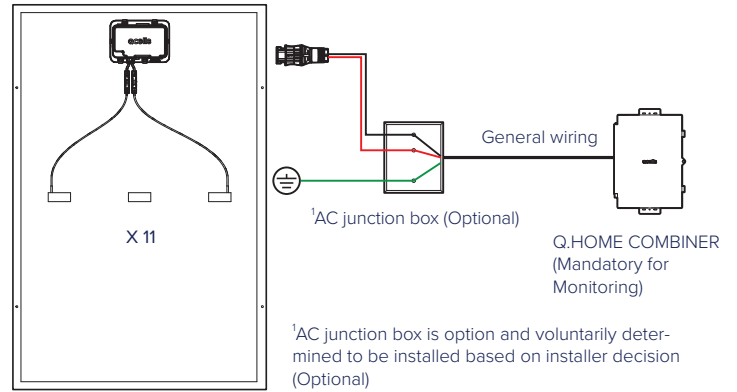

Transition Cable		
Conductor	Color	Description
L1 - L2	Black - RED	Line to line voltage 240 VAC
External Equipment Grounding Conductor (Array ↔ AC junction box)		
Ground	Green	Conductor to connect normally non-current carrying metal parts of equipment together
General Wiring		
L1 - L2	Black - RED	Line to line voltage 240 VAC
Ground	Green	Conductor to connect normally non-current carrying metal parts of equipment together

1. Check your distribution panel for figuring out what type of AC distribution system you have. Use a volt-meter to find out the phase and line-to-line voltage across L1, L2.
2. Check the extension/transition cables to verify they have not been pulled too tight or are hanging too loose. Attach cables on a structure like PV racks or rails using the cable clips. Also, place extension/transition cables or AC cables under a structure so that wires can avoid direct sunlight exposure and water immersion.
3. Connect the equipment grounding conductor from all of the AC modules to the Q.HOME COMBINER connecting to the distribution panel.
4. Make sure that a conduit or a small pipe protects wires from the Q.HOME COMBINER to the distribution panel from rain, snow or direct sunlight.

3 Planning

3.6 Electrical Installation

AC Connector Removal

Before pairing AC cable connectors, familiarize yourself with the following descriptions specifically explaining how to handle AC cable connectors and accessories.

A) Connect the middle part of the UNT-HQ-TOOL-G1 to the connector groove from the connector.

B) Pull both sides of the AC cable to remove connection of AC cable.

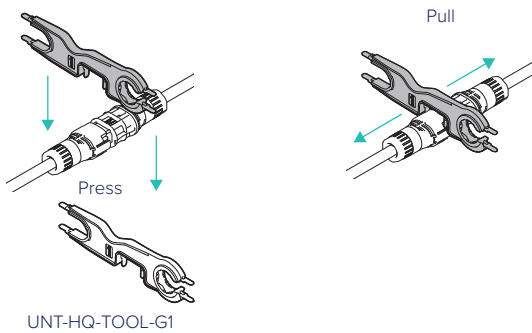

C) To remove the AC Cable from an microinverter, connect the edge part of the UNT-HQ-TOOL-1 to the connector groove from the Qcells microinverter.

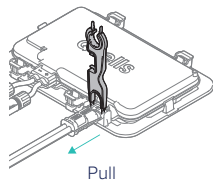

D) Pull the AC cable out of the microinverter.

- Avoid all external interference to the connector.
- Do not impose force on the side direction of the connector.
- Do not apply too much force on AC cables away from connectors or a microinverter.
- The cable must not be bent, crushed or pinched on the direct exit of the cable screw joint.
- The cable must be routed in a way that the tensile stress on the conductor or connections is prevented.
- A minimum bending radius $R \geq 55 \text{ mm}$ ($5 \times \text{Cable diameter}$) must be maintained.
- Do not attempt to assemble connectors in wet, soiled, or dusty environment.
- Keep connectors dry and clean, and ensure that connectors have no damage or deformation.
- Avoid connectors resting on the ground or roof surface. AC cables should be kept away from the ground or roof surface. Use proper tools like cable clips for securely attaching AC cables on structures like PV racks.
- Avoid sunlight exposure and water immersion of the connectors.
- Incomplete connections can result in arcs and electrical shock.
- Check that all AC cables are securely fastened to structures.
- Ensure that all locking connectors are fully engaged and locked.
- Do not leave unconnected (unprotected) connectors exposed to the environment. Only use dedicated end caps.



DANGER!

Risk of fatal injury due to electric shock!

- To prevent the danger of the electric shock, make sure to turn off the circuit breaker before the installation.
- Do not disconnect AC cable connectors under load.

AC Connector assembly instruction

Refer to the below instruction to assembly AC F/M Connector.

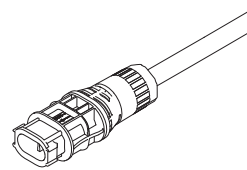

AC Connector Male

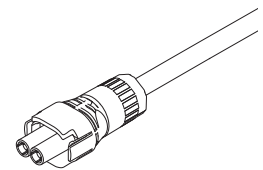

AC Connector Female

1. Cut the required cable length.

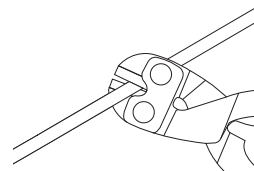

2. Insert the cable into the hole of the Male/Female housing

Male

Female

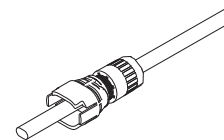
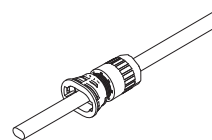

3. Using Branching pliers to Separate and cut off the insulation.

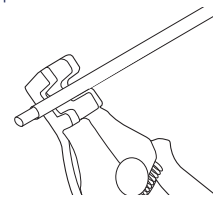
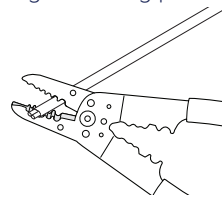

3 Planning

3.6 Electrical Installation

- Most installation issues are caused by improper wiring and crimping. Visually inspect the connector when finished assembling.
- Insert the cable cores until the insulation comes up against the crimp insert. Completely close the crimping pliers.

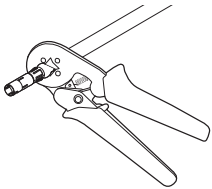

- Insert the terminal into the Male/Female body.

Male

Female

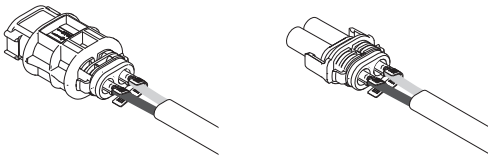

- Installing the housing on the Male/Female body.

Male

Female

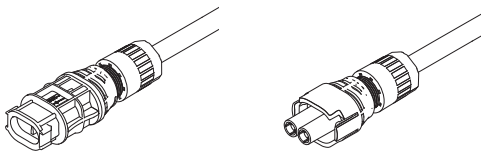

- Tighten the nut with the UNT-HQ-TOOL-G1.

Male

Female

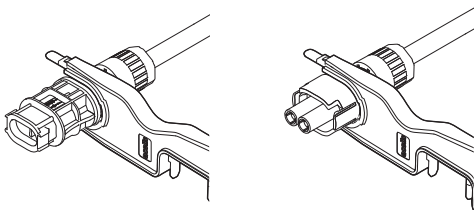

- Insulation cut off within 0.9 - 0.98inch (23 - 25mm).
- The striped cable should be controlled within 0.27 - 0.31inch (7 - 8mm)
- The gap between nut and housing must within 1.0 - 1.3mm.

AC Connector Explosion View

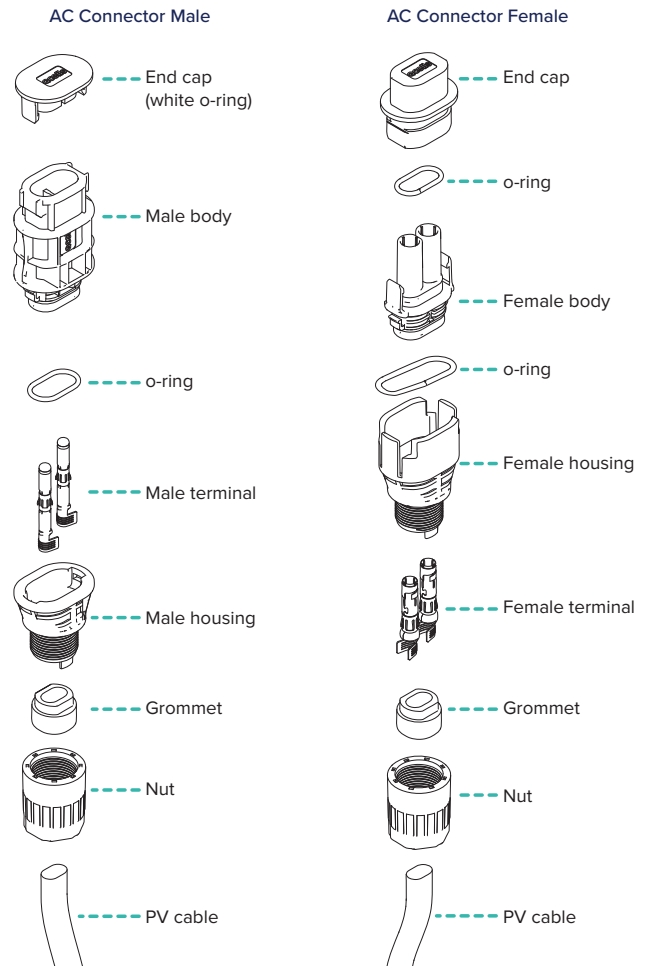

3 Planning

3.6 Electrical Installation

AC Connector End Cap

This diagram is for showing that each end cap has its pair.

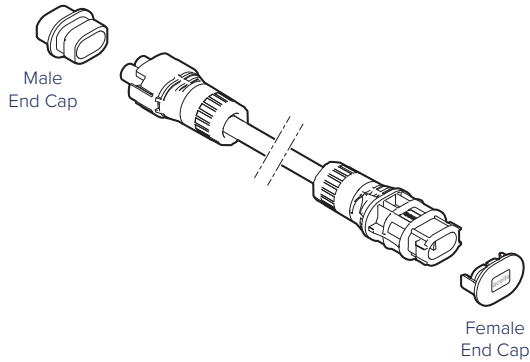

Manage the AC Cable

Fastening AC cables on PV racks or AC module frame.

- Keep the AC cables off from roof surface or ground.
- For cases of portrait in reverse or landscape in common, steps are described to recommend to fasten AC cables on AC module frames and PV racks.

For portrait in reverse or landscape in common,

A. Get the AC cable paired.

B. Use a mounting hole with a cable clip for fastening the AC cable on the ac module frame.

Mounting holes are placed in blue dots as displayed in the rear side of an AC module.

C. Attach another AC cable on near PV racks.

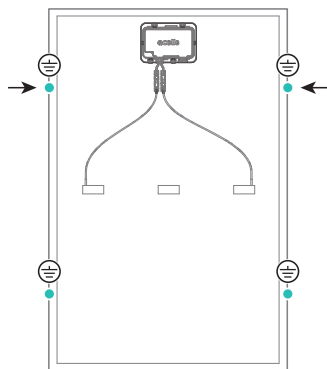

● Location of mounting hole

⊖ Location of grounding hole

→ Mounting holes can be used for cable clip

3 Planning

3.6 Electrical Installation

AC module for Array Design

AC junction box¹ is on the right side of a 3-by-4 PV array in portrait orientation.

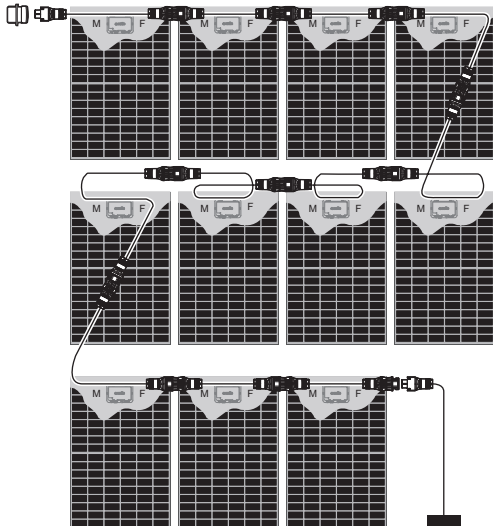

AC junction box¹ is on the left of a 3-by-4 PV array in portrait orientation.

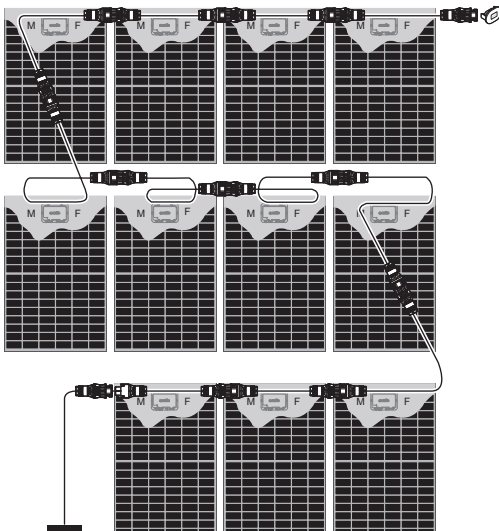

AC junction box¹ is on the right side of a 3-by-4 PV array in landscape orientation.

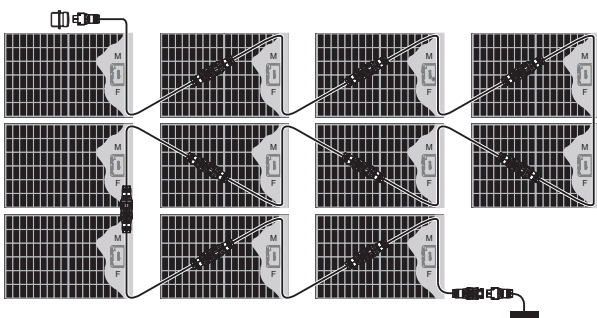

AC junction box¹ is on the left of a 3-by-4 PV array in landscape orientation.

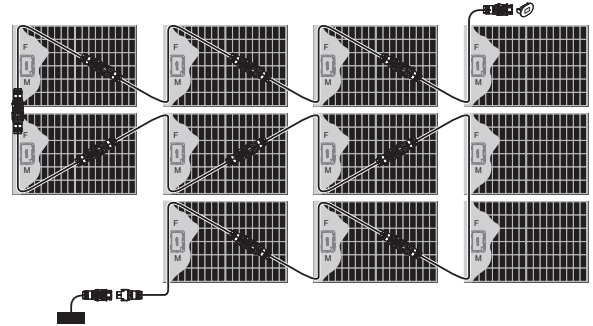

AC junction box¹ is on the right side of a 2-by-6 PV array in portrait orientation.

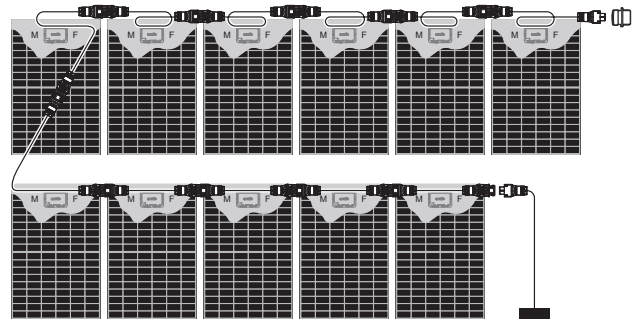

AC junction box¹ is on the left of a 2-by-6 PV array in portrait orientation.

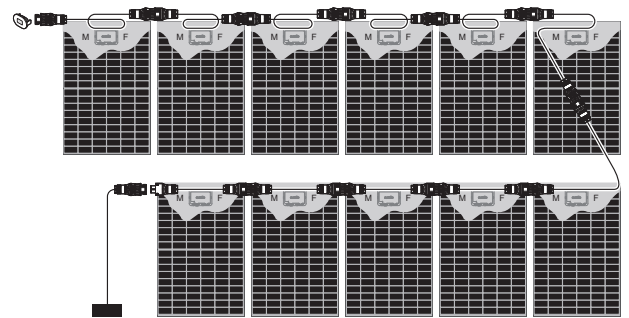

AC junction box¹ is on the right side of a 2-by-6 PV array in portrait orientation.

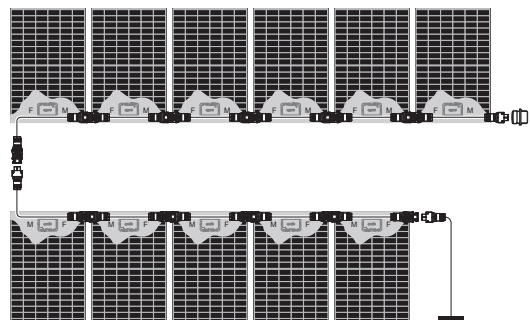

¹ AC junction box is option and voluntarily determined to be installed based on installer decision.

3 Planning

3.6 Electrical Installation

AC junction box¹ is on the left of a 2-by-6 PV array in portrait orientation.

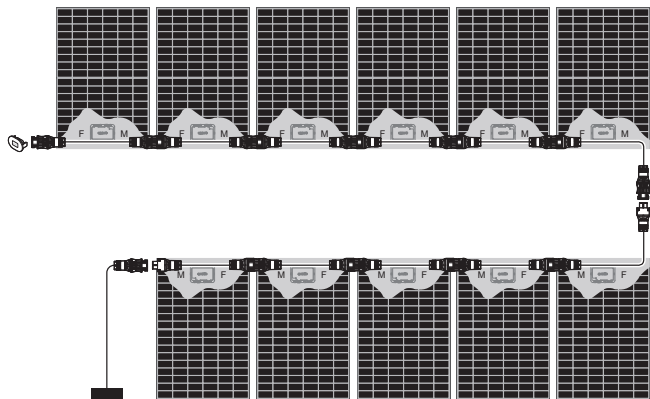

AC junction box¹ is on the left of a 2-by-6 PV array in portrait orientation.

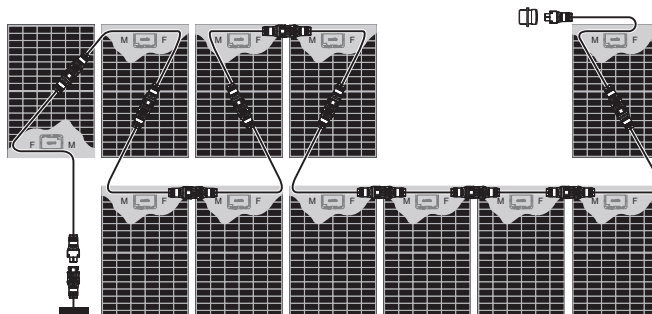

AC junction box¹ is on the right side of a 2-by-6 PV array in landscape orientation.

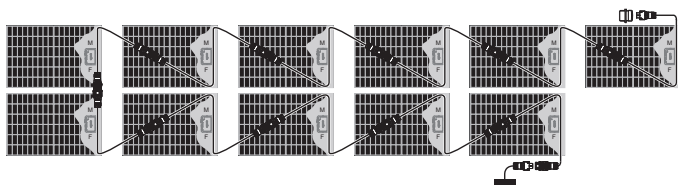

AC junction box¹ is on the left of a 2-by-6 PV array in landscape orientation.

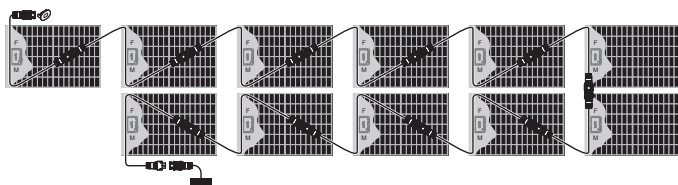

AC junction box¹ is on the right side of a 2-by-6 PV array in portrait orientation.

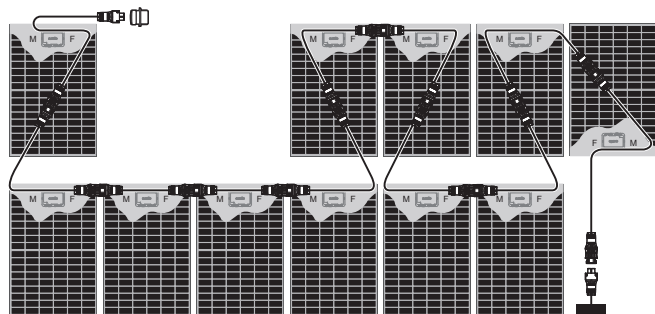

¹ AC junction box is option and voluntarily determined to be installed based on installer decision.

4 Installation

4.1 Safety and Transport

 → Ensure that all personnel are aware of and adhere to accident-prevention and safety regulations.
→ While working, wear clean gloves.

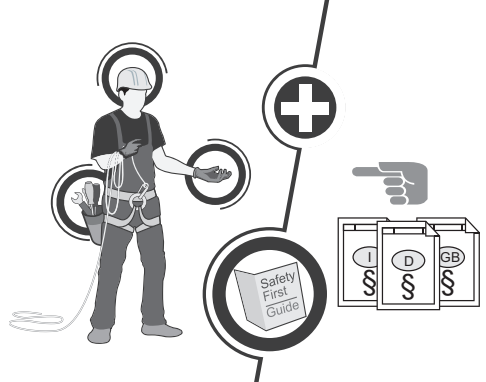

The illustration shows a worker wearing a hard hat, safety glasses, and a harness. To the right, there is a first aid kit with a cross symbol and a hand pointing to it. Below that are three manuals labeled 'Safety First Guide', 'D', and 'GB'.

 **Danger! Risk of fatal injury due to electric shock!**
→ Do not install damaged modules.
→ Inform your distributor of any damages immediately.



The illustration shows a solar panel with a magnifying glass focusing on a crack on its surface. To the right, there is a warning symbol (a triangle with an exclamation mark) and a magnifying glass over a hand holding a tool.

 → Inspect the packaging for damages.
→ Contact the transport company regarding any damage to the packaging and follow their instructions.
→ Follow any instructions on the packaging.



The illustration shows a person wearing safety glasses and a mask, inspecting a large Qcells solar module packaging on a pallet. To the right, there is a magnifying glass over an eye and a magnifying glass over a hand holding a tool.

 **Warning! Fire Risk!**
→ Do not install modules indoors.
→ Do not install modules on moving objects.
→ Do not use Qcells equipment in a manner not specified by the manufacturer. Doing so may cause death or injury to persons, or damage to equipment.



The illustration shows a house and a car with a solar panel on the roof. To the right, there is a prohibition sign (a circle with a diagonal line).

 → Leave modules in their original packaging until installation.
→ Store the modules securely in a dry location. The packaging is not weatherproof.

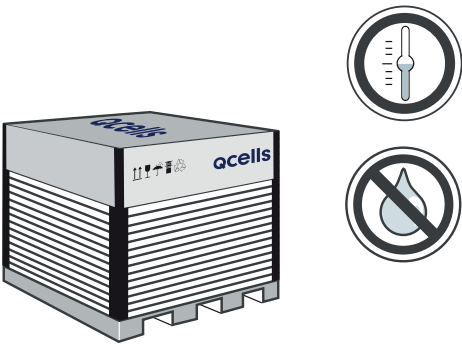

The illustration shows a Qcells solar module packaging on a pallet. To the right, there is a screwdriver icon and a water drop icon with a prohibition sign over it.

4 Installation

4.1 Safety and Transport

! Note! Module damage may occur!

- Never lift or move the module by the connection cables or junction box.
- Carry modules upright and horizontally as shown.

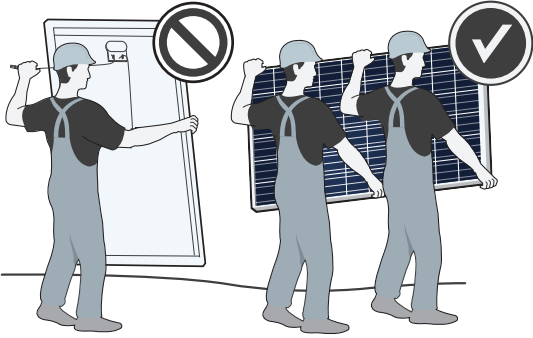

! Note! Module damage may occur!

- Never step on modules.
- Do not subject modules to any mechanical stress.
- Do not allow any objects to fall onto or scratch modules.

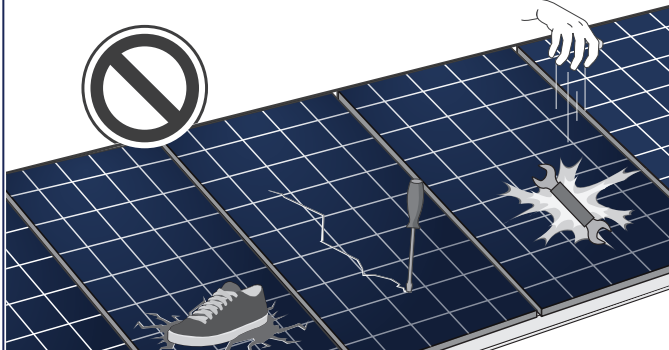

! Note! Module damage may occur!

- Do not drop modules.

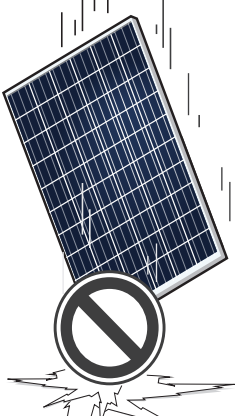

! Note! Module damage may occur!

- Only make modifications to the module which have been confirmed in writing by Qcells.

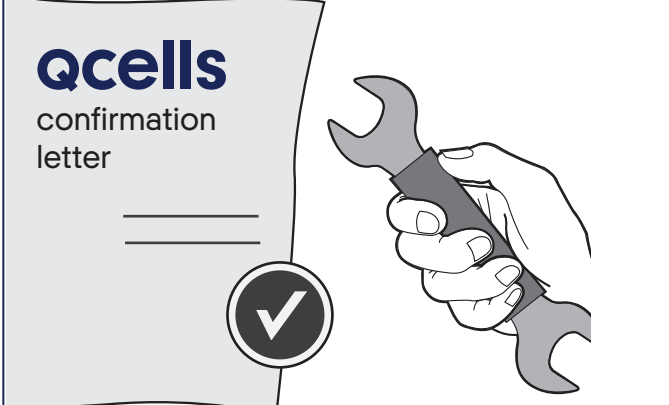

! Note! Module damage may occur!

- Do not stack modules.

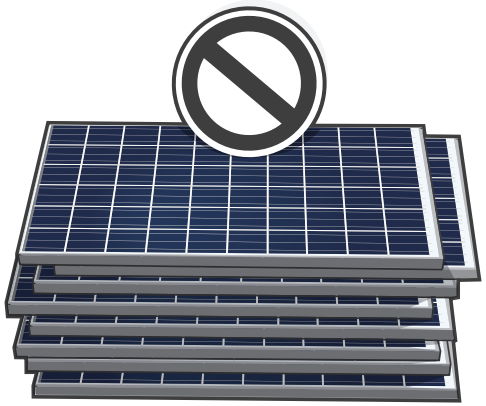

! Note! Module damage may occur!

- Do not install modules near flammable gas/vapors.
- Do not install modules in close proximity to air conditioning systems.

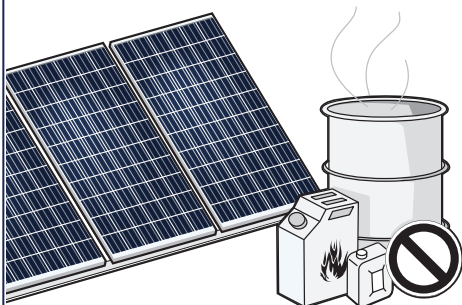

4 Installation

4.2 Preparation of Installation

! Danger! Risk of fatal injury due to electric shock!

- Block off the installation zone.
- Keep children and unauthorized individuals away from the solar power system.

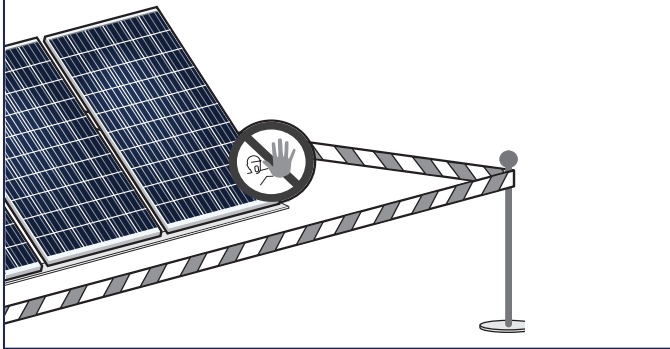

! Warning! Risk of injury due to falling modules!

- Secure modules during installation.
- Do not install modules in windy or wet weather.

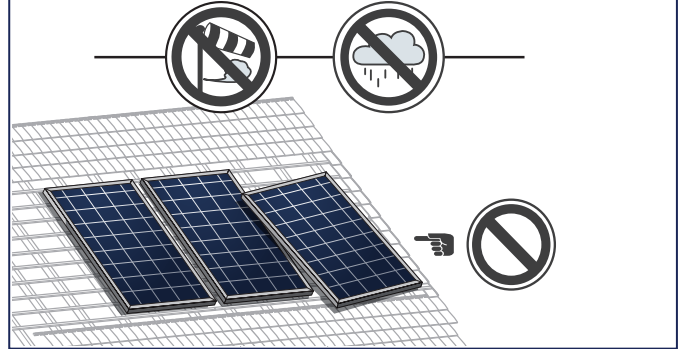

! Danger! Risk of fatal injury due to electric shock!

- Only use dry, insulated tools.



! Warning! Do not carry out the installation alone.

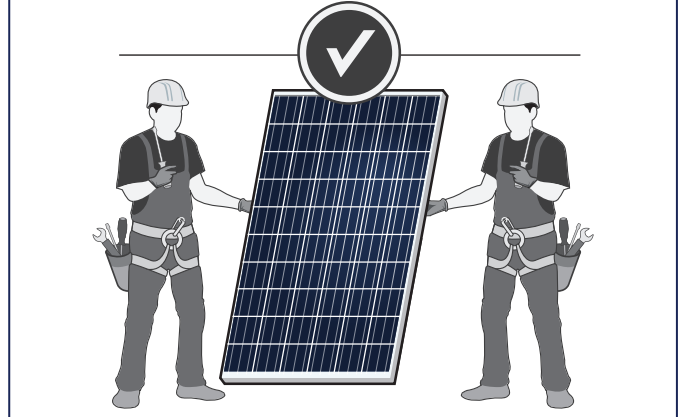

! Danger! Risk of fatal injury due to electric shock!

- Ensure that modules and tools are not subject to moisture or rain at any time during installation.



! Warning!

- Only install undamaged modules and components.
- Do not modify the module (e.g. do not drill any additional holes).

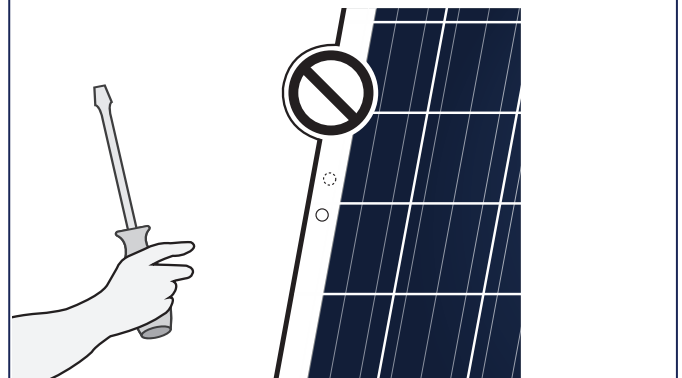

4 Installation

4.3 Module Installation

Option 1:

- Fasten the module with 4 clamps in the specified clamping range, see section "Mounting options with clamps" of chapter "3.5 Mounting Options".
- Tighten clamps according to manufacturer's instructions.

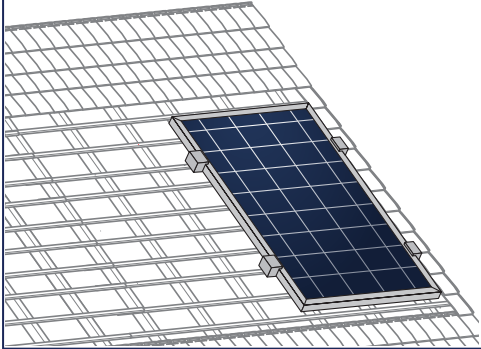

→ Maintain an interval of at least 0.39 in (10 mm) between two modules along the short side and 0.20 in (5 mm) along the long side.

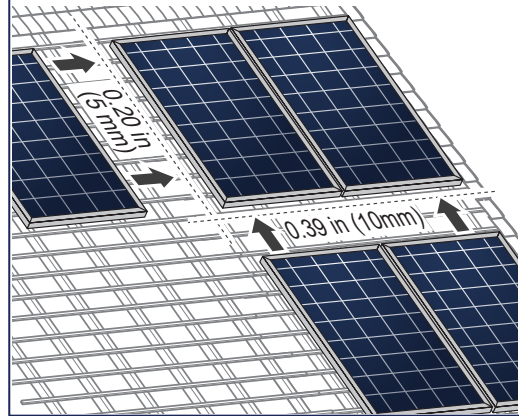

Option 2:

- Install the module at the 4 mounting points, see section "Mounting options with bolts" of chapter "3.5 Mounting Options".
- Tighten screws according to manufacturer's instructions.

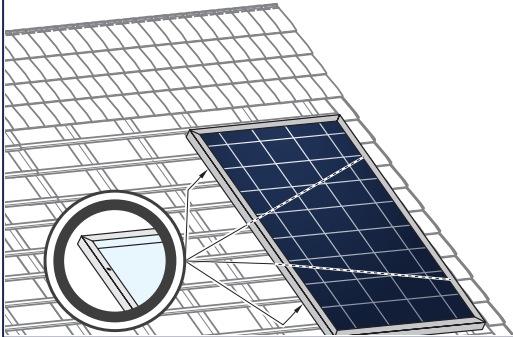

Note! Module damage may occur!

- Do not subject modules to mechanical tension. Max. torsion 0.12 in/ft (10 mm/m).

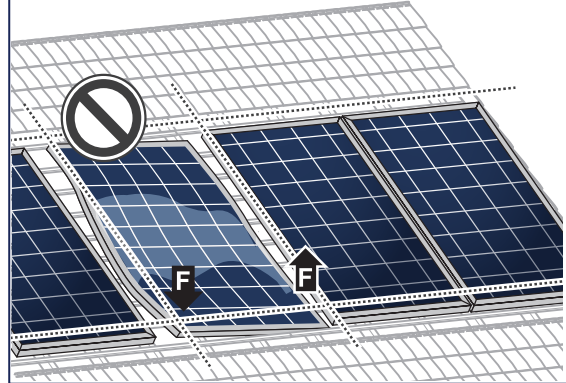

Option 3:

- Install the module using mounting profiles, see section "Mounting options with insertion profiles" of chapter "3.5 Mounting Options".

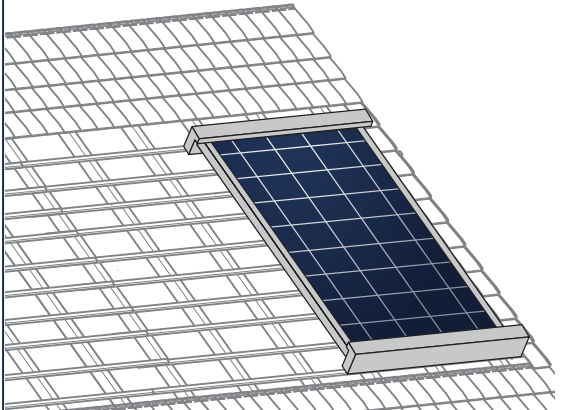

NOTE!

- Installing the Qcells AC module involves several key steps. Each step is listed in detail, please see page 3 - 6.

COMMON POINT

- Remove the QR code from each modules and place on the map* or scan the module serial number of each module via Q.OMMAND PRO in order of the physical array. A map template is found at the end of this manual.

5 Electrical Connection

5.1 Safety



DANGER!

Risk of fatal injury due to electric shock!

When disconnecting an electric circuit carrying direct current, electric arcs can occur that may result in life-threatening injuries.

- Do NOT unplug the cable when under load.
- Electrical work may only be performed by qualified and skilled personnel (see page 3).

A solar module generates electrical current and voltage even at a low intensity of illumination. Sparks and electric arcs may result from the separation of a closed circuit. These can result in life-threatening injuries.

- Please be aware of that the entire open circuit voltage is active even at low levels of solar irradiation.
- Please follow the valid national regulations and safety guidelines for the installation of electrical devices and systems.
- Carry out work with extreme caution.
- Ensure that branch circuit breakers are open prior to disconnecting AC Cable connections.
- Make sure that the plugs cannot be connected unintentionally.
- Do not exceed the maximum number of AC Modules in an AC branch as listed in the manual. You must protect each AC Module AC branch circuit with a 20A maximum breaker as appropriate.
- Do not connect Qcells AC Modules to the grid or energize the AC circuit(s) until you have completed all of the installation procedures and have received approval from the electrical utility company.
- The AC and DC connectors on the cabling are rated as a disconnect only when used with an Qcells AC Module.
- The Qcells AC Module is not protected from damage due to moisture trapped in cabling systems. Never mate microinverters to cables that have been left disconnected and exposed to wet conditions. This will void Qcells's warranty.



Danger! Risk of fatal injury due to electric shock!

- Only use dry, insulated tools for electrical work.

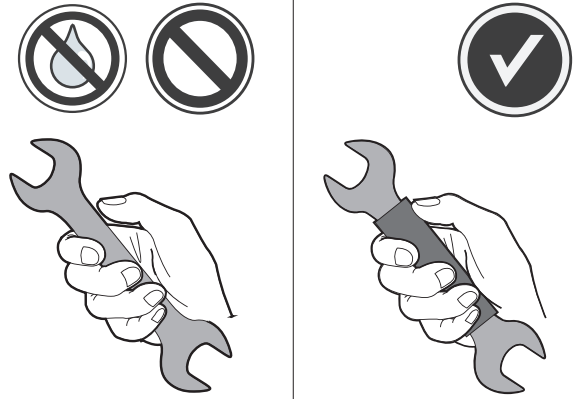

Danger! Risk of fatal injury due to electric shock!

- Never open the junction box.
- Do not remove bypass diodes.

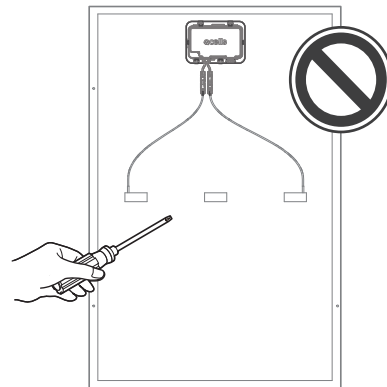

Danger! Risk of fatal injury due to electric shock!

- Never touch live contacts with bare hands.
- Cover connectors by suitable protective caps until installation.

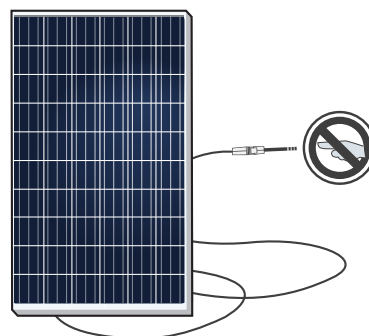

5 Electrical Connection

5.1 Safety



WARNING! Fire Risk!

- The body of the Qcells Microinverter is a heat sink. Under normal operating conditions, the temperature could be 68°F (20°C) above ambient, but under extreme conditions the microinverter may reach a temperature of 194°F (90°C). To reduce risk of burns, use caution when working with microinverters.

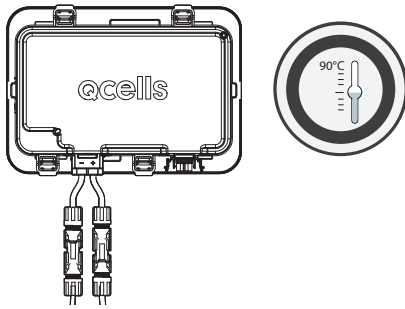

DANGER!

Risk of fatal injury due to electric shock!

- Never plug or unplug the cable when under load.
- Switch off the Qcells AC module, please see section "Safety" on page 3 .

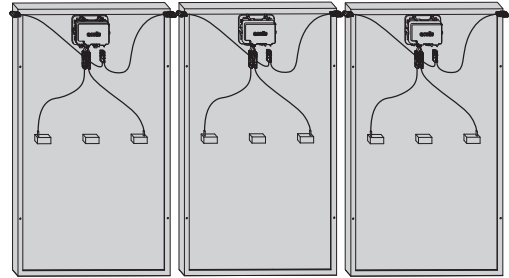

DANGER! Risk of fatal injury due to electric shock!

- Use the terminator to seal the conductor end of the Qcells AC cable: no other method is allowed.
- Only connect cables with plugs.

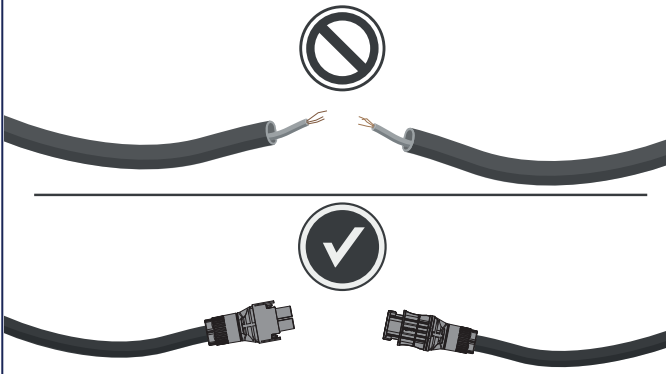



5 Electrical Connection

5.2 Connection of Modules

 → Only use connector and cables provided from Qcells (AC Cable, please see page 12).

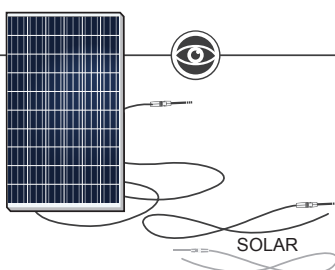
→ Use minimum AC cable minimum No. 12 AWG copper wires insulated for the field connections at least Use minimum AC cable minimum No. 12 AWG copper wires insulated for the field connections at least when connecting Q.HOME COMBINER to AC junction box. 194°F (90°C)



 **Note! Module damage may occur!**

→ Ensure that the cabling is not under mechanical stress (Comply with bending radius of ≥ 2.36 in (60 mm)).

→ Ensure that cables are ran free of all mechanical connections between modules and racking to avoid pinching, and possibly damaging insulation.

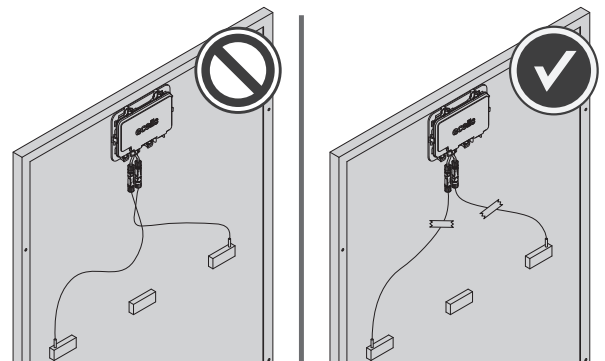

 **DANGER!**

Risk of fatal injury due to electric shock!

→ Ensure that all electrical components are in a proper, dry, and safe condition.

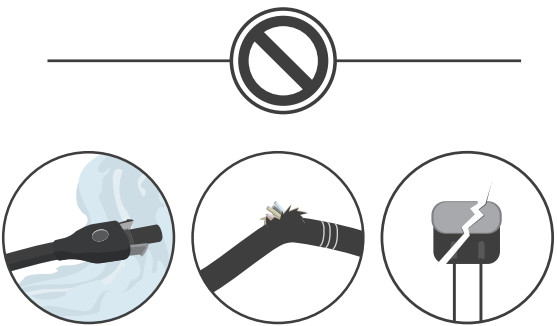

 → Ensure a tight connection between AC Cable connectors by ensuring plugs click together audibly.

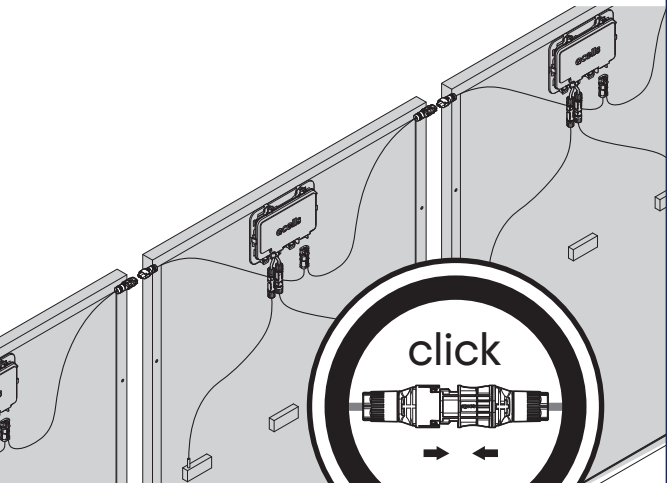

5 Electrical Connection

5.3 After Installation

 → Ensure that all necessary safety and functional tests have been carried out according to applicable standards.



 **CAUTION! Module damage may occur!**
→ Ensure that AC cable plug connections are secured away from any water-channelling surface.

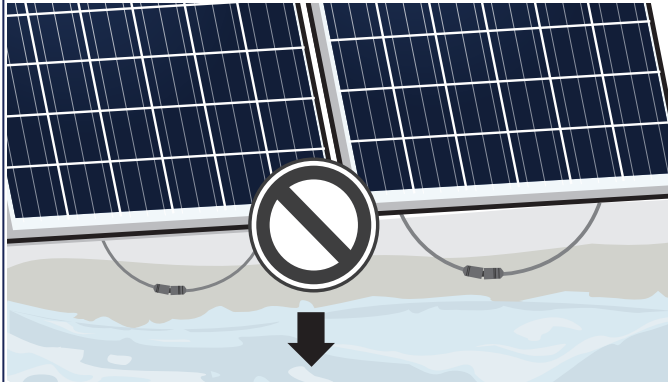

 → Use minimum AC cable No. 12 AWG copper wires insulated for a minimum of 90°C for field connections.
→ The Qcells AC module has field-adjustable voltage and frequency trip points that must be set during commissioning, depending upon local requirements. Only an authorized installer with the permission and following requirements of the local electrical authorities should make adjustments.

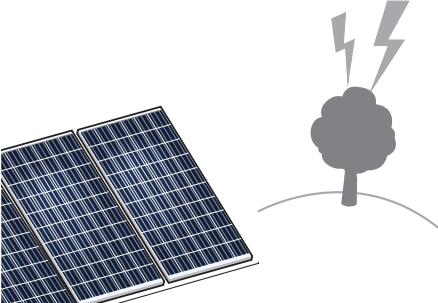

 **Warning! Fire Risk!**
→ Do not use light concentrators (e.g. mirrors or lenses).

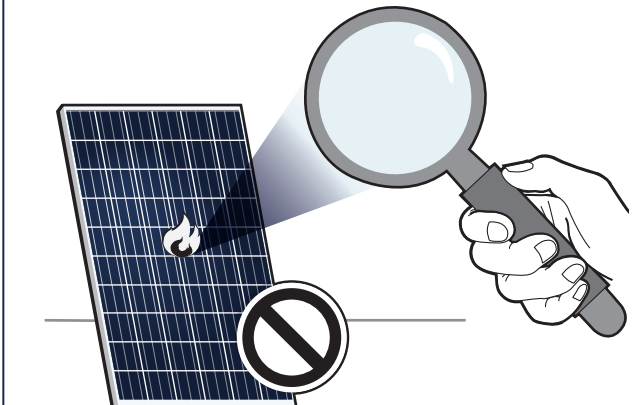

 → Ensure that the cabling is not exposed and/or hanging and is protected from dirt, moisture and mechanical friction.

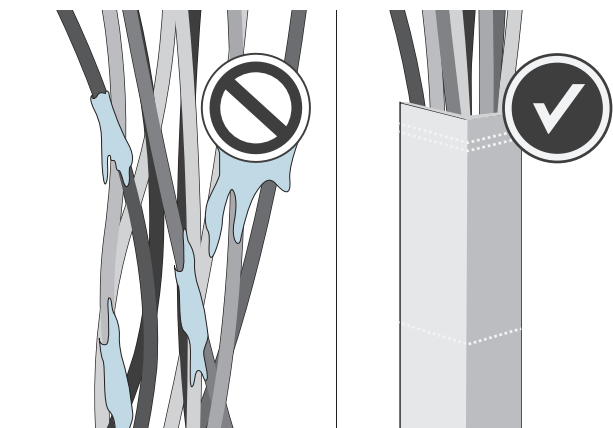

6 Grounding

Protective Grounding

In order to prevent electrical shock or fire, the frame of the module as well as any non-current-carrying metal parts of the system must be grounded. While this section provides some information about grounding the Qcells frames and modules, reference should be made to local statutes and regulations for specific requirements on grounding. The U.S. National Electrical Code addresses these issues in Article 250. A module with exposed conductive parts is considered to be in compliance with this standard only when it is either electrically grounded in accordance with the manufacturer's instructions and the requirements of the National Electrical Code, ANSI/NFPA 70 (2014-2017), or when the bonding means has been evaluated with this module to UL 2703.

Proper grounding is achieved by bonding all exposed non-current carrying metal equipment to the appropriately sized equipment grounding conductor (EGC) or racking system that can be used for integrated grounding.

Qcells frames are protected from corrosion with an anodized coating, which has to be penetrated in order to ensure proper bonding. The different methods listed below are suggested methods for an appropriate bond between the frame and the EGC or racking system (that will have to be properly grounded). The method appropriate for any individual installation will depend on multiple factors.

Care should be taken to avoid the use of grounding hardware of dissimilar metals, which may lead to corrosion.

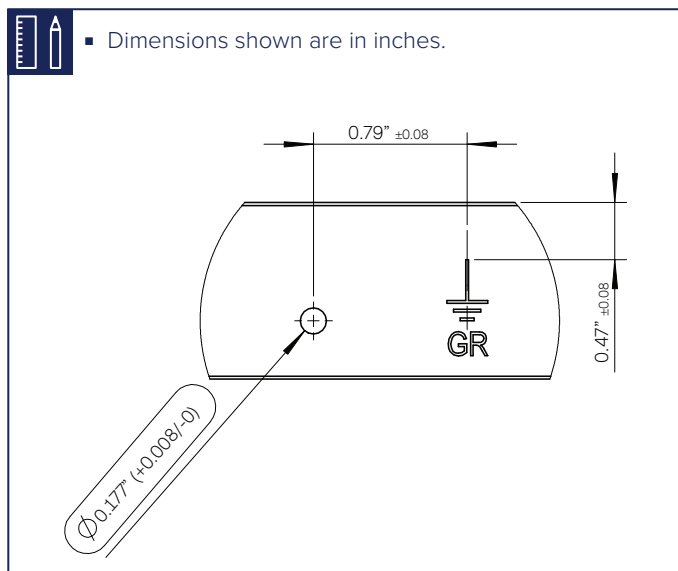

Option A: Use of a grounding lug

A listed grounding lug can be bonded to the frame using the grounding holes pre-drilled in the frame. These holes are marked with a ground symbol, as shown below on the frame section drawing: To install the grounding lug, follow the specified instructions of the manufacturer. The grounding lug should be made of stainless steel or tin plated metals such as aluminum to avoid corrosion.

The grounding lug should be attached to the frame grounding hole using a stainless steel screw, toothed lock washer or KEPS nut (in order to penetrate the anodized layer) and backing nut.

Option B: Integrated grounding methods

The Qcells modules can be bonded with the racking system using UL1703 or UL2703 certified integrated grounding methods. The racking system will then have to be grounded so that the overall system is properly grounded. The listed racking system and grounding device should be installed in accordance with the manufacturers' instructions. An example of such integrated grounding method is the use of a WEEB clip or Schletter plate between the module and the racking system, when mounting the module.

The WEEB washers are generally compatible with Qcells modules, however each combination module/racking system requires a specific WEEB washer size. Note that WEEB clips are intended for single use only; they must not be reused after removal or loosening. Refer to Wiley's installation instructions for the specific use of WEEB washers. (Refer to the link : <https://titan-wnc.com/products/grounding/wiley-weeb-washers/>)

An example of such integrated grounding method is the use of a washer recognized as meeting UL2703 requirements between the module and the racking system, when mounting the module. For example, WEEB washers are generally compatible with Qcells modules, however each combination module/racking system requires a specific WEEB washer size. Note that WEEB washers are intended for single use only; they must not be reused after removal or loosening. Refer to Wiley's installation instructions for the specific use of WEEB washers. (Refer to the Link : <https://titan-wnc.com/wp-content/uploads/2016/10/Wiley-Weeb-Washer-Cut-Sheet.pdf>)

6 Grounding

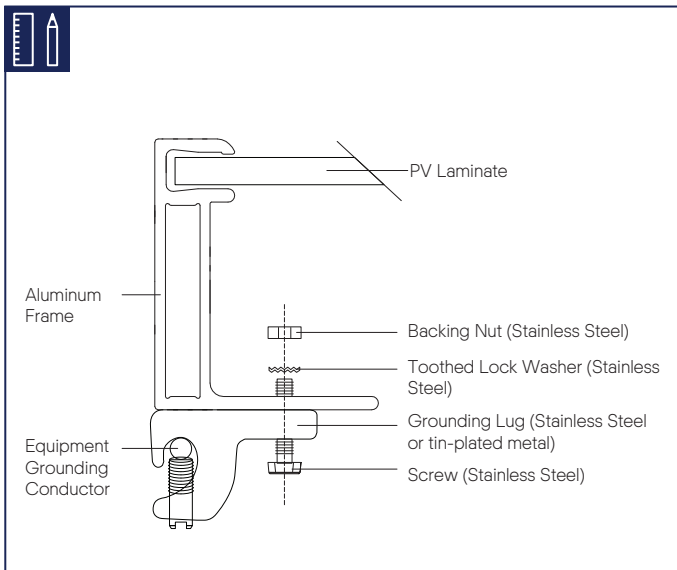

→ The modules must be grounded in accordance with the local statutory regulations.

- Determine the size of an external ground wire according to Article 690.45, NEC2020.
- All non-conductive metal parts should be grounded through the connection of the PV module frame.
- Those methods and devices are not evaluated by UL.
- Alternative grounding devices indicated in the appendix has been evaluated and approved by Qcells, not by UL.
- Please follow installation manual for the grounding devices provided by their manufacturer.

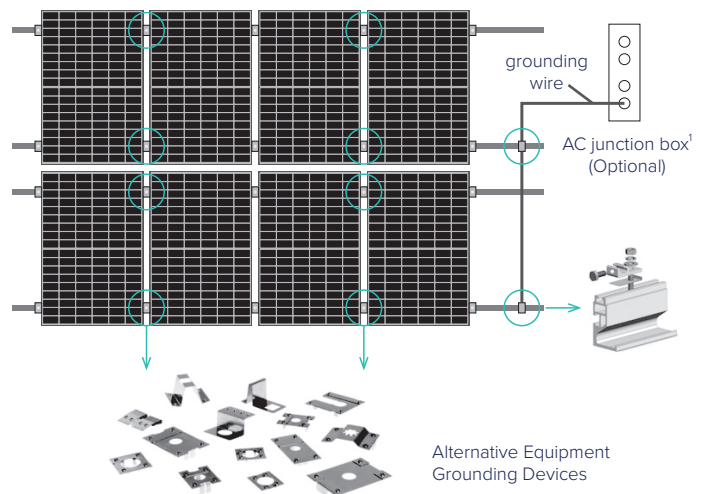

WARNING!

Risk of falling due to unsecured access!

- Do not use bare-copper grounding lugs for grounding.
- The lugs can corrode which could result in a faulty ground circuit thereby, posing risk for electric shock, electrocution or fire hazard.

¹ AC junction box is option and voluntarily determined to be installed based on installer decision

7 Faults and Defects



DANGER!

Risk of fatal injury due to electric shock!

- Do not attempt to fix any problems yourself (e.g., glass cracks, damaged cables).
- Please contact an installer or Qcells Technical Customer Service Department. (888) 249-7750 / na.support@qcells.com

8 Disposal

- Do not disconnect modules by yourself.
- Please commission a installers.
- Dispose of modules in accordance with the local disposal regulations.

9 Maintenance and Cleaning

Qcells solar modules are known for a long operating life and minimal maintenance effort and expense. Dirt and grime are usually washed away by rain. If the module is fully or partially shaded by dirt or debris (e.g., plants, bird droppings), it needs to be cleaned to prevent a loss of performance.

Maintenance

- The AC PV system has to be inspected regularly by certified personnel
- The time intervals and extent of the inspection can depend on local circumstances (e.g. salt, ammonia content in the air, high humidity etc.). The customer/operator must inform himself about time intervals and extend of necessary inspections.
- Inspections have to be performed especially after extraordinary events (e.g. storm, hail, high snow loads etc.)
- During the inspections it has to be checked that the components are secure, undamaged and clean

Cleaning



WARNING!

Risk of injury due to hot and live modules!

- Only clean modules that have cooled down.
- Do not carry or wear any electrically conductive parts.



WARNING!

Risk of falling due to unsecured access!

- Never access the installation area alone or without taking adequate safety precautions.
- Please commission a trade specialist.



NOTE!

Module surface damage may occur!

- Remove snow and ice carefully without force (e.g. with a very soft broom).
- Do not scratch off dirt.
- Module cleaning has to be done by qualified personnel according to the state of the art and taking into account all relevant safety issues and general product properties, e.g., but not restricted to:
 - electrical safety
 - mechanical stability (load limits depending on the actual mounting options)
 - chemical suitability (no effect to any of the module's components, e.g. cable, connector, silicone)
 - no abrasive materials.



NOTE!

Dust and dirt are abrasive materials!

- The situation for each individual project (or type of dirt) must always be professionally evaluated.
- Wrong cleaning may cause damages such as, but not limited to, damages to the glass surface (e.g. scratches) and AR coating, power loss, delamination, loss of frame-to-laminate bond, reduced snow and wind load capability etc.

Apart from the above, each customer is free to choose the method of cleaning. However, possible damages, caused by the cleaning or related to the cleaning tools or agents shall not be covered by the module's Product and Performance Warranty. Therefore it is recommended to use only the tools and agents which have already been specifically designed and used with PV modules, to prevent possible damage.

Isopropyl alcohol (IPA) can be used selectively to remove stubborn dirt and strains.



Note! Module damage may occur!

- Do not clean modules with water if there is a risk of freezing.

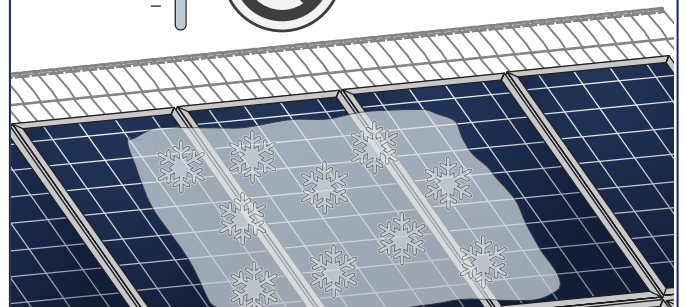

- Free the substructure from any dirt and debris (leaves, bird nests, etc.).

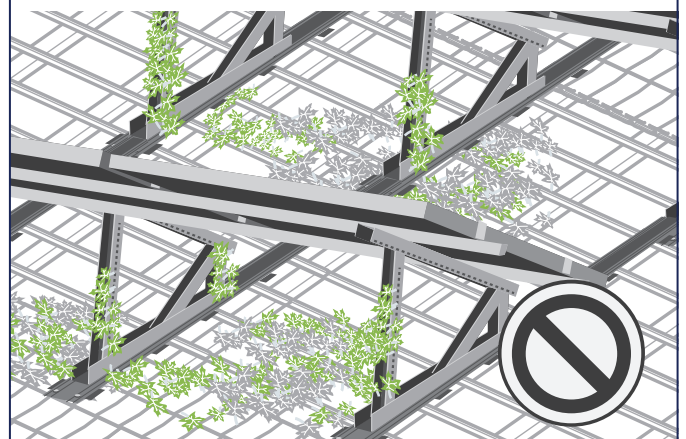

10 Sample Wiring Diagram – Single Phase

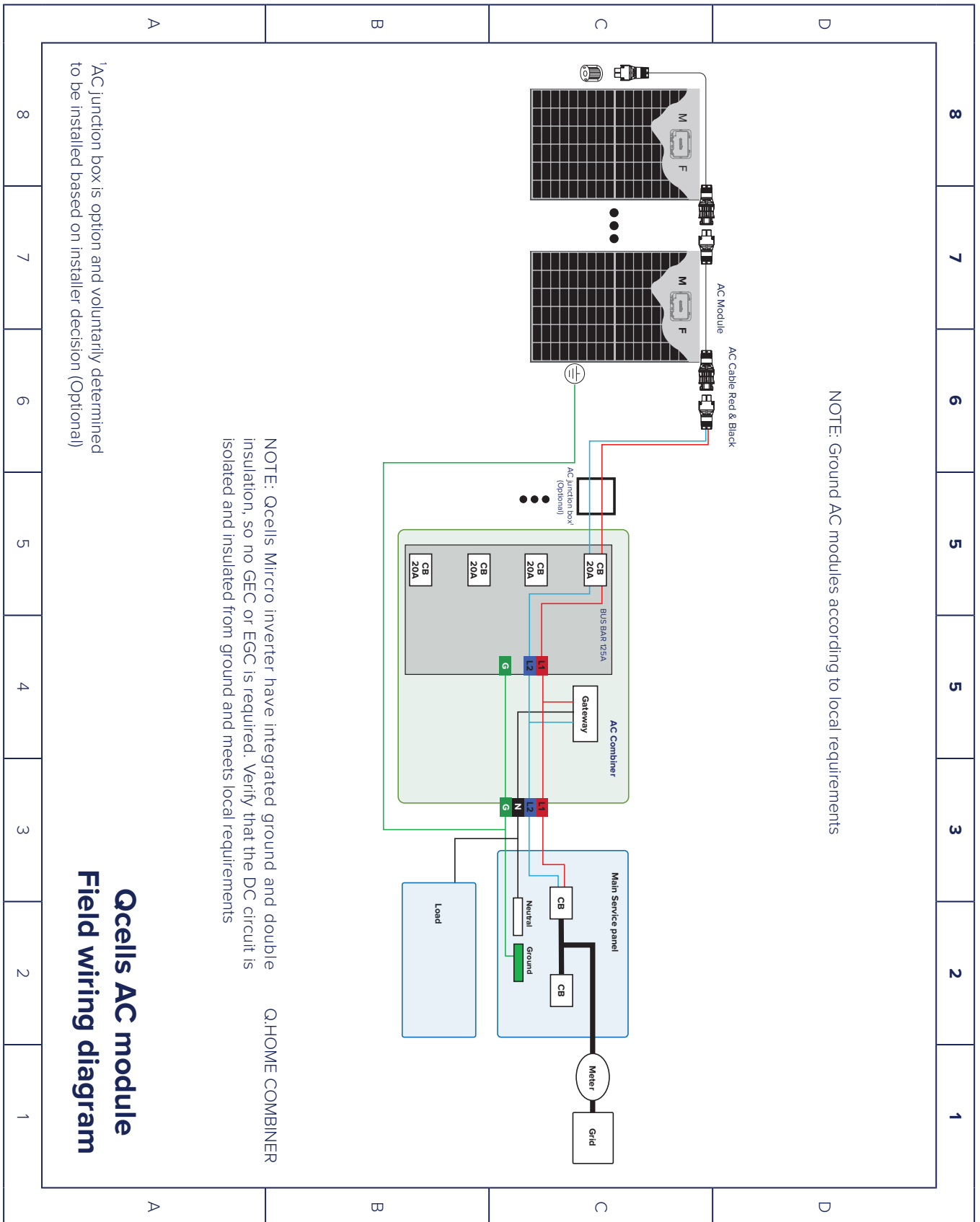

NOTE: Ground AC modules according to local requirements

NOTE: Qcells Micro inverter have integrated ground and double insulation, so no GEC or EGC is required. Verify that the DC circuit is isolated and insulated from ground and meets local requirements

Q:HOME COMBINER

¹AC junction box is option and voluntarily determined to be installed based on installer decision (Optional)

Qcells AC module
Field wiring diagram

11 Array & Mapping with Q.OMMAND PRO

11.1 Q.OMMAND PRO App

To commission the product via mobile, search and install the Q.OMMAND PRO app from the Apple App Store or Google Play Store. Scan the QR code below to access to Q.OMMAND PRO manual.



Android



iOS

11.2 Q.OMMAND PRO Web

To commission the product via desktop, visit : qommand.qcells.com

Note

If you do not yet have an account, you will need to register as an installer and generate an account prior to commissioning the system via Q.OMMAND PRO.

11.3 Q.OMMAND PRO Manual

Scan the QR code below to access to Q.OMMAND PRO manual.



12 Trouble Shooting Guide

Q.OMMAND PRO APP	Description	Recommended Action
M001	Microinverter no Power (Link Voltage error)	<ol style="list-style-type: none"> 1. Check the connection status. 2. Disconnect the DC (PV) connector (wait for 10 seconds) and reconnect it. 3. If error persists, contact customer support.
M002	Microinverter no Power (Temp error)	<ol style="list-style-type: none"> 1. Check the connection status. 2. Disconnect the DC (PV) connector (wait for 10 seconds) and reconnect it. 3. If error persists, contact customer support.
M003	Grid frequency out of range of operation	<ol style="list-style-type: none"> 1. Check Grid profile setting. 2. Check Grid voltage and Frequency in monitoring. 3. If the system frequency is 0Hz, Check the circuit breaker and AC connector wiring. (Check Microinverter to distribution box connection) 4. Check Utility meter grid voltage and frequency. 5. If there is no problem with the system, contact customer support.
M004	Grid voltage out of range of operation	<ol style="list-style-type: none"> 1. Check Grid profile setting. 2. Check Grid voltage and Frequency in monitoring. 3. If the system voltage is 0V, Check the circuit breaker and AC connector wiring. (Check Microinverter to distribution box connection) 4. Check Utility meter grid voltage and frequency. 5. If there is no problem with the system, contact customer support.
M005	Microinverter no Power (Memory error)	<ol style="list-style-type: none"> 1. Check the connection status. 2. Disconnect the DC (PV) connector (wait for 10 seconds) and reconnect it. 3. If error persists, contact customer support.
M006	Microinverter no Power (Output current over)	<ol style="list-style-type: none"> 1. Check the connection status. 2. Disconnect the DC (PV) connector (wait for 10 seconds) and reconnect it. 3. If error persists, contact customer support.
M007	Microinverter no Power (Internal Diagnosis error)	<ol style="list-style-type: none"> 1. Check the connection status. 2. Disconnect the DC (PV) connector (wait for 10 seconds) and reconnect it. 3. If error persists, contact customer support.
M008	PV voltage out of range of operation	<ol style="list-style-type: none"> 1. Check PV Module status and PV connector connection. 2. Check PV Voltage. 3. If there is a problem with PV status, replace the AC module. 4. If PV condition is OK, contact customer support.
M009	Microinverter no Power (Input current over)	<ol style="list-style-type: none"> 1. Check the connection status. 2. Disconnect the DC (PV) connector (wait for 10 seconds) and reconnect it. 3. If error persists, contact customer support.
M010	Microinverter no Power (Temp sensor error)	<ol style="list-style-type: none"> 1. Check the connection status. 2. Disconnect the DC (PV) connector (wait for 10 seconds) and reconnect it. 3. If error persists, contact customer support.
M011	Microinverter no Power (Unintentional Islanding)	<ol style="list-style-type: none"> 1. If error persists, Check Grid status. 2. Check the circuit breaker and AC connector wiring. 3. Disconnect the DC (PV) connector (wait for 10 seconds) and reconnect it. 4. If there is no problem with the system, contact customer support.
M012	Microinverter no Power (ADC error)	<ol style="list-style-type: none"> 1. Check the connection status. 2. Disconnect the DC (PV) connector (wait for 10 seconds) and reconnect it. 3. If error persists, contact customer support.
M013	Microinverter no Power (Over Surge Detection)	<ol style="list-style-type: none"> 1. Check the connection status. 2. Disconnect the DC (PV) connector (wait for 10 seconds) and reconnect it. 3. If error persists, contact customer support.
M014	Microinverter no Power (Function check error)	<ol style="list-style-type: none"> 1. Check the connection status. 2. Disconnect the DC (PV) connector (wait for 10 seconds) and reconnect it. 3. If error persists, contact customer support.
M015	Microinverter Not Reporting	<ol style="list-style-type: none"> 1. Check AC/DC connector wiring. 2. Disconnect the DC (PV) connector (wait for 10 seconds) and reconnect it. 3. If there is no problem with AC/DC connector wiring, contact customer support.

13 Installation Map

Sheet ____ of ____

To Sheet _____▲

Physical Layout Template



Customer

Installer

Array _____

Azimuth _____

Tilt _____

qcells

	A	B	C	D	E	F	G	H	I	J	K
1											
2											
3											
4											
5											
6											

▲ To Sheet _____

▲ To Sheet _____

To Sheet _____▼

